

## CC-Link IE TSN Installation Manual

This document describes items to examine beforehand, items to check when configuring a network using CC-Link IE TSN-compatible products, and precautions for installation at the installation site. We hope this document helps you smoothly configure CC-Link IE TSN.

## Revision history

Sub No.	Revision description	Issued date
*	First edition	November 2018
A	<ul style="list-style-type: none"> <li>2.2, 3.1.1, and 3.2.3.1: A connector for 100 Mbps communication has been added.</li> <li>2.3: Wiring examples when star wiring topology is mixed with another one have been corrected. Precautions for coexistence of authentication classes have been added.</li> <li>2.3 and 3.1: The function names have been corrected.</li> <li>3.1.1: The numbers of core have been divided into 1 Gbps and 100 Mbps and described.</li> <li>2.3, 3.2.1, and 3.3.2: Correction of mistakes</li> </ul>	April 2019
B	<ul style="list-style-type: none"> <li>2.2, 2.3, and 3.1: The descriptions of IEEE 1588 and IEEE 802 have been corrected.</li> <li>2.3 and 3.1: The definitions of the authentication classes of devices and switches have been corrected.</li> </ul>	May 2020
C	<ul style="list-style-type: none"> <li>2.1, 2.2, 3.1.2, 3.1.3, and 3.2.3: The descriptions of 10-pin rectangular connectors compliant with IEC 61076-3-124 have been added.</li> </ul>	March 2023
D	<ul style="list-style-type: none"> <li>The omission was corrected.</li> </ul>	July 2023
E	<ul style="list-style-type: none"> <li>Table 2.3-3 in 2.3: The definition of the master station was added and omissions were corrected.</li> </ul>	October 2023

## Contents

<b>1. NETWORK INSTALLATION PROCEDURE</b> .....	5
1.1. Network Installation Procedure.....	5
<b>2. NETWORK SPECIFICATIONS</b> .....	6
2.1. Overview of the Network Specifications .....	6
2.2. Communication Specifications .....	8
2.3. Topology .....	10
<b>3. TWISTED PAIR CABLE</b> .....	14
3.1. Selecting Devices to Be Connected.....	14
3.1.1. Cable.....	14
3.1.2. Connector.....	15
3.1.3. Relay connector .....	15
3.1.4. Switch .....	15
3.2. Checking Wiring.....	16
3.2.1. Wiring length.....	16
3.2.2. Number of connectors.....	18
3.2.3. Precautions on connectors and cable connections .....	18
3.2.3.1. RJ45 connector.....	18
3.2.3.2. M12 connector .....	19
3.2.3.3. 10-pin rectangular connector (Compliant with IEC 61076-3-124, Type A) .....	21
3.2.3.4. Precautions on connector connection.....	22
3.2.4. Transmission characteristics .....	23
3.3. Installation and Wiring .....	26
3.3.1. Precautions on installation .....	26
3.3.2. Grounding method .....	28
3.3.2.1. Additional explanation about grounding .....	28
<b>4. OPTICAL FIBER CABLE</b> .....	31
4.1. 1 Gbps (Optical) .....	31
4.1.1. Selecting devices to be connected .....	31
4.1.1.1. Optical fiber cable.....	31
4.1.1.2. Optical connector .....	31
4.1.2. Checking wiring.....	32
4.1.2.1. Wiring length.....	32
4.1.2.2. Number of connectors .....	32
4.1.2.3. Precautions on connectors and cable connections .....	32
4.1.2.4. Transmission characteristics.....	33

4.1.3. Installation and wiring .....	35
4.1.3.1. Precautions on installing cable .....	35
4.1.3.1.1. Installation .....	35
4.1.3.1.2. Fusion splicing and adapter connection.....	37
4.1.3.2. Grounding method .....	37
4.2. 100 Mbps (Optical) .....	38
4.2.1. Selecting devices to be connected .....	38
4.2.1.1. Optical fiber cable.....	38
4.2.1.2. Optical connector .....	38
4.2.2. Checking wiring.....	38
4.2.2.1. Wiring length.....	38
4.2.2.2. Precautions on connectors and cable connections.....	38
4.2.2.3. Transmission characteristics .....	38
4.2.3. Installation and wiring .....	39
4.2.3.1. Precautions on installing cable .....	39
4.2.3.1.1. Installation .....	39
4.2.3.1.2. Fusion splicing and adapter connection.....	40
4.2.3.2. Grounding method .....	40
APPENDIX .....	41
A. Supplementary Explanation Supporting Twisted Pair Cables .....	41
A1. Conductor structure of FA cable .....	41
A2. Pin end height (crimp height).....	42
A3. Deformation of connector.....	42

## 1. NETWORK INSTALLATION PROCEDURE

### 1.1. Network Installation Procedure

The installation procedure is shown in Figure 1.1-1.

For the system design, check the precautions in this entire document.

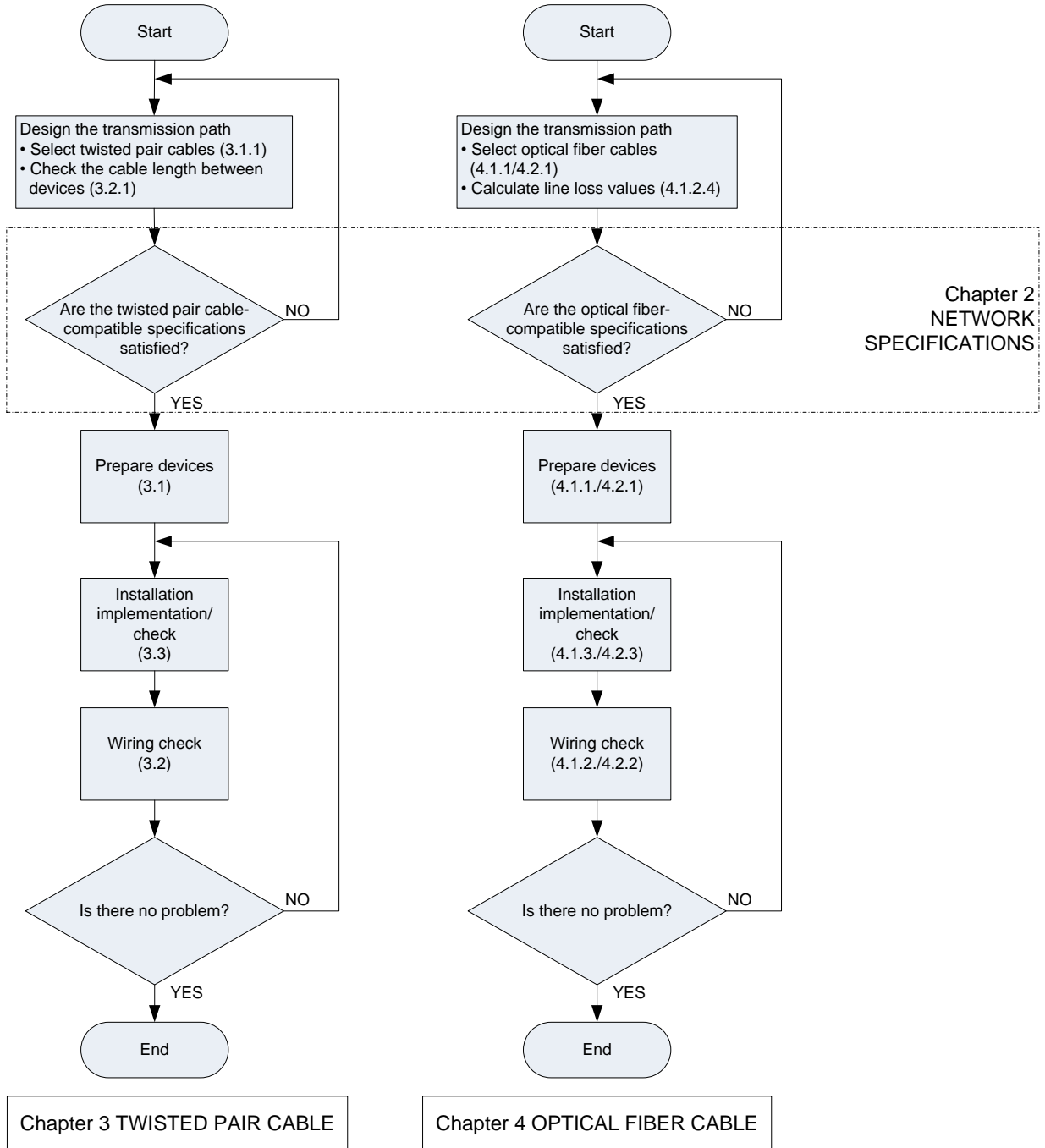

Figure 1.1-1 Installation procedure

## 2. NETWORK SPECIFICATIONS

### 2.1. Overview of the Network Specifications

Components of CC-Link IE TSN

Station: Station indicates an element that configures the network and sends/receives data.  
There are the following station types.

#### **Master station**

A generic term for management master stations and control master stations.

#### **Slave station**

A general term for all stations other than master stations.

#### **Management master station**

A control master station that performs network management. Only one station exists on the same network.

#### **Control master station**

A station that has control information (parameters), and controls slave stations and other master stations through cyclic transmission and transient transmission.

#### **Local station**

A station that can perform n:n cyclic transmission with master stations and other local stations, 1:n cyclic transmission with other stations, and transient transmission with other stations. In transient transmission, the local station has the server function and client function.

#### **Remote station**

A station that can perform 1:n cyclic transmission and transient transmission with other stations. In transient transmission, the remote station has the server function and client function.

Connection cable: Use cables compatible with the wiring parts test specifications.

#### **Twisted pair cable**

##### **1 Gbps**

Use cables compliant with ANSI/TIA/EIA-568-B (Category 5e or higher).

##### **100 Mbps**

Use cables compliant with ANSI/TIA/EIA-568-B (Category 5 or higher).

#### **Optical fiber cable**

##### **1 Gbps (optical)**

Use cables compliant with IEC 60793-2-10 Types A1a.1 (50/125  $\mu\text{m}$  multimode).

##### **100 Mbps (optical)**

Use POF cables and HPCF cables compliant with the CLPA wiring component testing specifications.

Connector: Use connectors compliant with the specifications.

## **Twisted pair cable**

### **1 Gbps**

Use RJ45 connectors compliant with ANSI/TIA/EIA-568-B 8-pin connectors. Or, use X-Coding 8-pole M12 connectors compliant with IEC 61076-2-109. Or, use 10-pin rectangular connectors Type A compliant with IEC 61076-3-124.

### **100 Mbps**

Use RJ45 connectors compliant with ANSI/TIA/EIA-568-B 8-pin connectors. Or, use D-Coding 4-pole M12 connectors compliant with IEC 61076-2-101 or X-Coding 8-pole M12 connectors compliant with IEC 61076-2-109. Or, use 10-pin rectangular connectors Type A compliant with IEC 61076-3-124.

## **Optical fiber cable**

### **1 Gbps (optical)**

Use duplex LC type connectors compliant with IEC 61754-20 (Type LC connectors).

### **100 Mbps (optical)**

Use connectors compliant with IEC 61754-16 (Type PN connector) or IEC 61754-24 (Type SC-RJ connector).

Relay connector: This connector is used to connect between cables when installing twisted pair cables or optical fiber cables and ensures independence, maintainability, and environmental resistance of devices. It is also used when twisted pair cables are used inside the panel and single-wire cables are used outside the panel to reduce stress on the connector connecting part of the device.

Switch: The switch is a relay device which has multiple Ethernet ports and transfers frames. Also, switches for line connection and star connection can coexist.

## 2.2. Communication Specifications

CC-Link IE TSN uses the IEEE802.3 1000BASE-T, 1000BASE-SX, and 100BASE-TX technologies. The communication specifications related to cable laying for CC-Link IE TSN are shown in Table 2.2-1.

Table 2.2-1 Communication specifications

Item			Specifications
Communication speed			1 Gbps/100 Mbps
Maximum cyclic size per station			Max. 4G (4,294,967,296) octet in total per station
Transient transmission			With the server function and client function for each station The transmission capacity is the same as SLMP.
Communication method			Time sharing method Time managed polling method
Synchronization function			Compliant with IEEE 802.1AS and IEEE 1588
Number of nodes connected to one network			64,770 devices (total of master/slave stations)
Maximum distance between nodes			<ul style="list-style-type: none"> <li>Twisted pair cable (compliant with IEEE 802.3): 100 m</li> <li>Optical fiber (IEEE 802.3 compliant multimode fiber): 550 m</li> </ul>
Maximum number of branches			No upper limit
Topology			Line, star, line/star mixed, ring, ring/star mixed, mesh
Connection specifications	Twisted pair cable specifications	Cable specifications	1 Gbps: IEEE 802.3 1000BASE-T compliant cable ANSI/TIA/EIA-568-B (Category 5e or higher) compliant shielded or double shielded type is recommended.  100 Mbps: IEEE 802.3 100BASE-TX compliant cable ANSI/TIA/EIA-568-B (Category 5 or higher) shielded or double shielded type is recommended.
		Connector specifications	RJ45 connector(1 Gbps): The shielded RJ45 compliant with ANSI/TIA/EIA-568-B 8-pin connectors is recommended.  RJ45 connector (100 Mbps): The shielded RJ45 compliant with the ANSI/TIA/EIA-568-B 4-pin or 8-pin connector is recommended.  M12 connector (1 Gbps): The X-Coding 8-pin connector compliant with IEC 61076-2-109 is recommended.  M12 connector (100 Mbps): The D-Coding 4-pin connector compliant with IEC 61076-2-101 or X-Coding 8-pin connector compliant with IEC 61076-2-109 is recommended.  10-pin rectangular connector (1 Gbps/100 Mbps): The 10-pin connector Type A compliant with IEC 61076-3-124 is recommended.



Item		Specifications	
Connection specifications	Optical fiber cable specifications (1 Gbps)	Optical fiber specification	Optical fiber cable compliant with IEEE 802.3 1000BASE-SX (MMF)
		Standard	IEC 60793-2-10 Types A1a.1 (50/125 $\mu\text{m}$ multimode)
		Transmission loss (max)	3.5 (dB/km) or less ( $\lambda = 850 \text{ nm}$ )
		Transmission band (min)	500 (MHz/km) or higher ( $\lambda = 850 \text{ nm}$ )
		Optical fiber specification	GI type plastic optical fiber cable (GI-POF)
		Standard	Proposing IEC 60793-2-40 (core 55 $\mu\text{m}$ , external diameter 490 $\mu\text{m}$ multimode)
		Transmission loss (max)	100 (dB/km) or less ( $\lambda = 850 \text{ nm}$ )
		Transmission band (min)	350 (MHz/km) or higher ( $\lambda = 850 \text{ nm}$ )
		Connector specifications	Duplex LC type connector
		Standard	IEC 61754-20: Type LC connector
	Connection loss	0.3 (dB) or less	
	Polished surface	PC polishing	
	Optical fiber cable specifications (100 Mbps)	Optical fiber specification	SI type plastic optical fiber cable (SI-POF)
		Standard	-
		Transmission loss (max)	170 (dB/km) or less ( $\lambda = 650 \text{ nm}$ )
		Transmission band (min)	10 (MHz/km) or higher ( $\lambda = 650 \text{ nm}$ )
		Connector specifications	SI type plastic clad fiber cable (SI-PCF)
		Standard	-
		Transmission loss (max)	19 (dB/km) or less ( $\lambda = 650 \text{ nm}$ )
		Transmission band (min)	14 (MHz/km) or higher ( $\lambda = 850 \text{ nm}$ )
Connector specifications		F07 type connector	
Standard		IEC 61754-16: Type PN connector	
Connection loss	0.8 (dB) or less (for master fiber)		
Polished surface	Not defined		

## 2.3. Topology

The topologies that can be configured with CC-Link IE TSN are line, star, line/star mixed, ring, ring/star mixed, and mesh. Star wiring uses switches and ring/star mixed and mesh wiring use switches compliant with IEEE802.1CB. Note that the applicable topology may differ depending on the device. For the details of the function, performance, and system configuration, check the specifications of the devices and switches to be used. Use a recommended cable even for a connection cable between switches.

Table 2.3-1 Topology

Topology	Wiring example	Point
Line		<ul style="list-style-type: none"> <li>• Cables are used to connect the ports of each station.</li> <li>• The master station can be placed at an arbitrary location.</li> </ul>
Star		<ul style="list-style-type: none"> <li>• Cables are used to connect the ports of switches and ports of the station.</li> <li>• The master station can be placed at an arbitrary location.</li> </ul>
Line/star mixed		<ul style="list-style-type: none"> <li>• Cables are used to connect the ports of switches and the ports of the station or ports between stations.</li> <li>• Multiple switches can be connected.</li> <li>• The master station can be placed at an arbitrary location.</li> </ul>
Ring		<ul style="list-style-type: none"> <li>• Ports of each station are connected using cables to configure a ring.</li> <li>• The master station can be placed at an arbitrary location.</li> </ul>
Ring/star mixed		<ul style="list-style-type: none"> <li>• Cables are used to connect ports of switches compliant with IEEE802.1CB and ports of the station or ports between stations.</li> <li>• Outside the ring, star wiring is possible using switches.</li> <li>• The master station can be placed at an arbitrary location.</li> </ul>
Mesh		<ul style="list-style-type: none"> <li>• Cables are used to connect ports of switches compliant with IEEE802.1CB and ports of the station or ports between stations.</li> <li>• The master station can be placed at an arbitrary location.</li> </ul>

A wiring example in which 1 Gbps compatible devices and 100 Mbps compatible devices coexist is shown below. When 1 Gbps compatible devices and 100 Mbps compatible devices coexist, the performance of the entire network is equivalent to 100 Mbps. Depending on the device, a switch may be required to connect between a 1 Gbps compatible device and a 100 Mbps compatible device.

**Table 2.3-2 Coexistence of 1 Gbps compatible devices and 100 Mbps compatible devices**

Topology	Wiring example	Point
Line		<ul style="list-style-type: none"> <li>When 1 Gbps compatible devices are connected via 100 Mbps, the performance of those devices is equivalent to 100 Mbps.</li> </ul>
Star		<ul style="list-style-type: none"> <li>1 Gbps compatible devices and 100 Mbps compatible devices can coexist via a switch.</li> <li>1 Gbps compatible devices and 100 Mbps compatible devices can be placed at arbitrary positions, respectively.</li> </ul>
Line/star mixed		<ul style="list-style-type: none"> <li>1 Gbps compatible devices and 100 Mbps compatible devices can coexist via a switch.</li> <li>When 1 Gbps compatible devices are connected via 100 Mbps, the performance of those devices is equivalent to 100 Mbps.</li> </ul>
Ring		<ul style="list-style-type: none"> <li>It is possible for 1 Gbps compatible devices and 100 Mbps compatible devices to coexist but the performance of the entire network is equivalent to 100 Mbps.</li> </ul>

When an authentication class B device station and an authentication class A device station coexist in the same CC-Link IE TSN system, part or all of the network will have the functionality and performance equivalent to those of authentication class A.

Table 2.3-3 Definitions of authentication classes for devices

○: Required, -: Optional

No.	Function	Condition	Device station		Master station
			Authentication class A	Authentication class B	Authentication class B
1	Receive/relay	Full rate receive/relay (*1)(*2)	-	○	- (*9)
2	Supported standard	IEEE 802.1AS compliant	-	○	○
		IEEE 1588 compliant	- (*5)	- (*5)	- (*5)
		IEEE 802.1Qbv compliant	-	○	○
3	Synchronization accuracy	1 μs or less	-	○ (*4)	○ (*4)
4	Communication method	Time sharing method	- (*5)	○	○
		Time managed polling method	○ (*6)	-	○ (*6)
5	Cyclic transmission	VLAN	○ (*6)	○ (*6)	- (*7)
		Unicast	○	○	○
		Broadcast/multicast	- (*3)	○	- (*8)
6	Transient transmission	NRSV-Transient	○	○	○

\*1 1 port: Receive, 2 or more ports: Receive and relay

\*2 Any communication speed equal to or higher than 100 Mbps is available.

\*3 Multicast implementation is necessary for the local station.

\*4 To guarantee the accuracy of 1 μs for the time synchronization, configure a system only with authentication class B products.

In this case, do not place an authentication class A product (including a switch) between authentication class B products.

\*5 When the protocol version is 1.0, implementation is required.

\*6 When the protocol version is 1.0, implementation is required.

\*7 When an authentication class B or A device station is connected, implementation is recommended.

\*8 When the master station supports the local station connection, implementation is required.

\*9 When the master station has two or more ports and supports the relay function, implementation is required.

Table 2.3-4 Coexistence of authentication classes

Topology	Wiring example	Point
Line	<p style="text-align: center; font-size: small;">The functionality and performance of this slave station are equivalent to that of the authentication class A.</p>	<ul style="list-style-type: none"> <li>• When authentication class A devices coexist, the function/performance of subsequent devices is equivalent to that of authentication class A.</li> </ul>
	<p style="text-align: center; font-size: small;">The functionality and performance of the entire network are equivalent to that of the authentication class A.</p>	<ul style="list-style-type: none"> <li>• When the master station is authentication class A, the function/performance of the entire network is equivalent to that of authentication class A.</li> </ul>

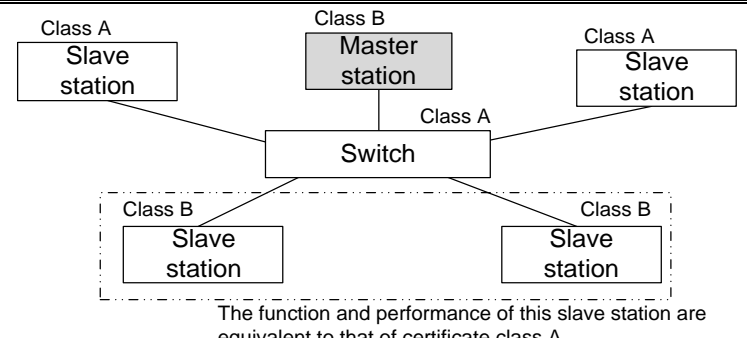
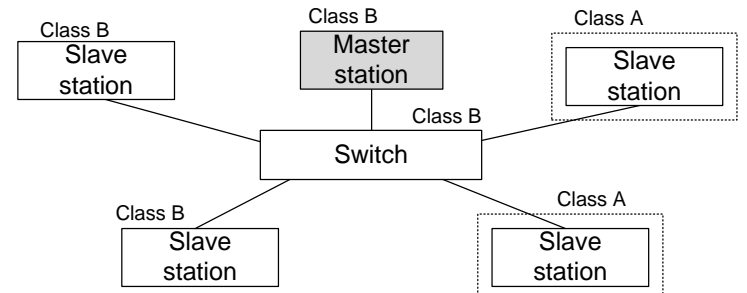
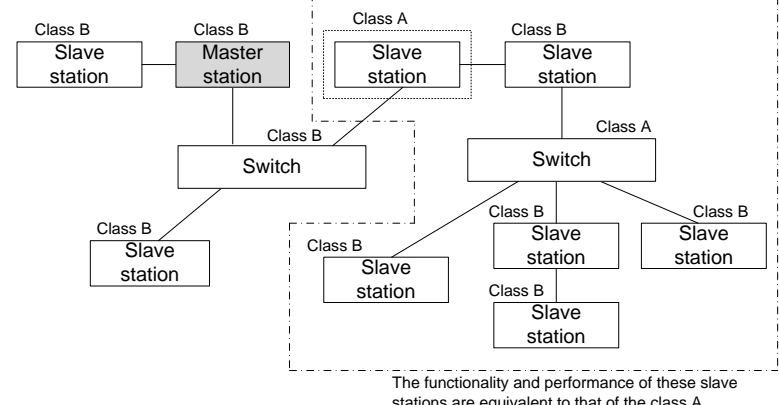
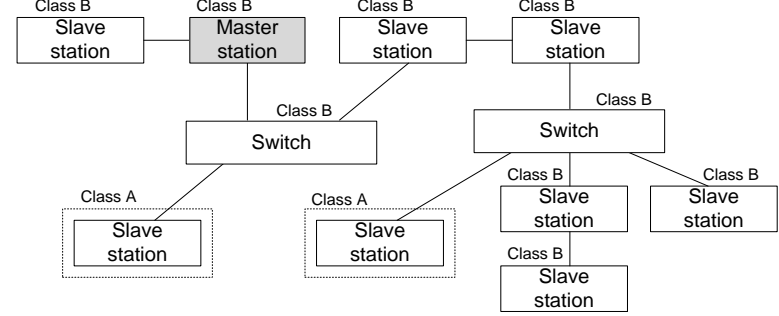
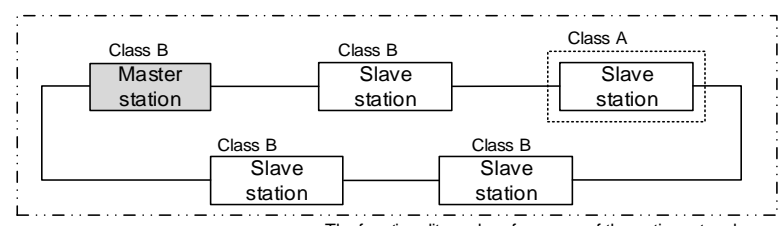
Topology	Wiring example	Point
Star	 <p style="text-align: center;">The function and performance of this slave station are equivalent to that of certificate class A.</p>	<ul style="list-style-type: none"> <li>• When the switch of certificate class A is used, the functions and performance of the slave stations following the switch are equivalent to that of certificate class A.</li> <li>• By being connected to a switch of certificate class B, a device of certificate class A can be connected to the high-accuracy synchronization communication network.</li> </ul>
		
Line/star mixed	 <p style="text-align: center;">The functionality and performance of these slave stations are equivalent to that of the class A.</p>	<ul style="list-style-type: none"> <li>• When authentication class A devices coexist in line wiring, the function/performance of subsequent devices is equivalent to that of authentication class A.</li> <li>• By being connected to a switch of certificate class B, a device of certificate class A can be connected to the high-accuracy synchronization communication network.</li> </ul>
		
Ring	 <p style="text-align: center;">The functionality and performance of the entire network are equivalent to that of the authentication class A.</p>	<ul style="list-style-type: none"> <li>• When authentication class A devices coexist, the function/performance of the entire network is equivalent to that of authentication class A.</li> </ul>

## 3. TWISTED PAIR CABLE

### 3.1. Selecting Devices to Be Connected

It is recommended to use products that passed the CLPA test.

When selecting cables and connectors, make sure that they are the proper combinations with respect to wire conductor size (AWG), conductor structure (single-wire, twisted-wire), outer diameter of insulator, external diameter of cable, shielding, category, and others.

For details, refer to Section 3.2.3.

#### 3.1.1. Cable

For CC-Link IE TSN, twisted pair cables compliant with the ANSI/TIA/EIA-568-B standard can be used.

Table 3.1-1 Recommended cables for CC-Link IE TSN

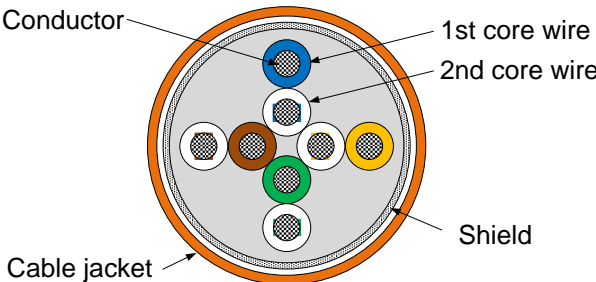
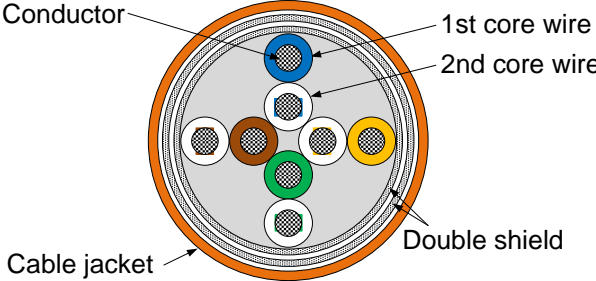
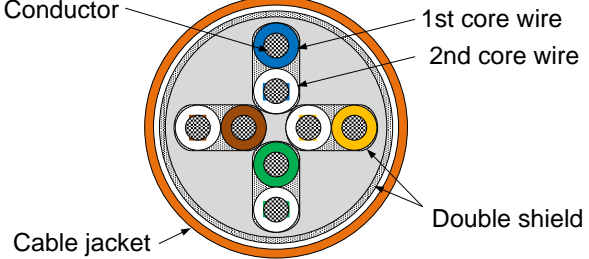
Item	Specifications												
Cable types	4-pair branched cable Shielded or double shielded type												
Compliant standard	ANSI/TIA/EIA-568-B 1 Gbps: Category 5e or higher 100 Mbps: Category 5 or higher												
Number of core wires	1 Gbps: 8 cores (4 pair twist) 100 Mbps: 8 cores (4 pair twist) or 4 cores (2 pair twist)												
Cross section example	<div style="display: flex; align-items: flex-start;"> <div style="margin-right: 20px;">Shield type</div>  <table border="1" style="margin-left: 20px;"> <thead> <tr> <th colspan="2">Core wire identification (insulator color)</th> </tr> <tr> <th>1st core wire</th> <th>2nd core wire</th> </tr> </thead> <tbody> <tr> <td>Blue</td> <td>White/Blue</td> </tr> <tr> <td>Orange</td> <td>White/Orange</td> </tr> <tr> <td>Green</td> <td>White/Green</td> </tr> <tr> <td>Brown</td> <td>White/Brown</td> </tr> </tbody> </table> </div>	Core wire identification (insulator color)		1st core wire	2nd core wire	Blue	White/Blue	Orange	White/Orange	Green	White/Green	Brown	White/Brown
	Core wire identification (insulator color)												
	1st core wire	2nd core wire											
Blue	White/Blue												
Orange	White/Orange												
Green	White/Green												
Brown	White/Brown												
	<table border="1" style="margin-left: 20px;"> <thead> <tr> <th>Type</th> <th colspan="2">Shield material</th> </tr> </thead> <tbody> <tr> <td rowspan="2">Shielded</td> <td>Aluminum tape</td> <td>-</td> </tr> <tr> <td>Annealed copper wire braid</td> <td>-</td> </tr> <tr> <td>Double shielded</td> <td>Aluminum tape</td> <td>Annealed copper wire braid</td> </tr> </tbody> </table>	Type	Shield material		Shielded	Aluminum tape	-	Annealed copper wire braid	-	Double shielded	Aluminum tape	Annealed copper wire braid	
Type	Shield material												
Shielded	Aluminum tape	-											
	Annealed copper wire braid	-											
Double shielded	Aluminum tape	Annealed copper wire braid											
	<div style="display: flex; justify-content: space-around;"> <div style="margin-right: 20px;">Double shielded type</div>   </div>												

Note) • When wiring a long distance, use a single-wire conductor cable of 24 AWG or higher. For details, refer to Section 3.2.

- When wiring a short distance, to prevent stress on the connector connecting part it is recommended to use a twisted-wire conductor cable or a movable cable that is flexible and easy to handle.
- When constructing an installation route with a special environment inside a factory (for example: heat-resistant, oil-resistant or moving part), select environmentally friendly materials. For the environmental resistance of each material, refer to the specifications of each manufacturer.
- In accordance with the communication environment in the factory, select either shielded or double shielded type. Compared to the shielded type, the double shielded type has enhanced shielding performance.

### 3.1.2. Connector

Use RJ45 connectors with shielding compliant with ANSI/TIA/EIA-568-B. Category 5e or higher connectors are recommended.

For M12 connectors (1 Gbps), use 8-pole X-Coding connectors compliant with IEC 61076-2-109.

For M12 connectors (100 Mbps), use 4-pole D-Coding connectors compliant with IEC 61076-2-101 or 8-pole X-Coding connectors compliant with IEC 61076-2-109.

For 10-pin rectangular connectors (IEC 61076-3-124), use connectors Type A compliant with IEC 61076-3-124.

### 3.1.3. Relay connector

Use relay connectors compliant with the ANSI/TIA/EIA-568-B (Category 5e) RJ45 jack specification.

For M12 connectors, use relay connectors compliant with IEC 61076-2-101 or IEC 61076-2-109.

Also, use relay connectors with shielding.

For 10-pin rectangular connectors (IEC 61076-3-124), use relay connectors Type A compliant with IEC 61076-3-124.

### 3.1.4. Switch

For CC-Link IE TSN, switches that satisfy the authentication conditions shown in Table 3.1-2 are recommended. The repeater HUB is not available.

In order to guarantee highly accurate synchronous communication, use authentication class B switches. When a ring/star mixed or mesh wiring topology is used, use switches compliant with IEEE802.1CB.

Table 3.1-2 Definition of switch authentication class

○: Required, -: Optional

No.	Compliant standard		Authentication class	
			A	B
1	Link-up/relay	Compliant with 1000BASE-T (IEEE802.3ab)	○ (*)	○ (*)
		Compliant with 100BASE-TX (IEEE802.3u)		
		Auto MDI/MDI-X	○	○
		Auto negotiation	○	○
2	Supported standard	Compliant with IEEE1588	-	○
		Compliant with IEEE802.1AS	-	○
3	Synchronization accuracy	1 μs or lower	-	○
4	Time aware Queuing	Compliant with IEEE802.1Qbv	-	○

\* Must be compliant with one or both of them.

## 3.2. Checking Wiring

Wiring between devices (or switches) of CC-Link IE TSN should be compliant with ANSI/TIA/EIA-568 Category 5e. When installing, confirm the following items.

- 1) Wiring length (see Section 3.2.1)
- 2) Number of connectors (see Section 3.2.2)
- 3) Connection between connectors (plug/jack) and cable (See Section 3.2.3.)
- 4) Transmission characteristics (see Section 3.2.4.)

### 3.2.1. Wiring length

In the CC-Link IE TSN specification, the maximum physical wiring length between devices is 100 m. (Devices means the CC-Link IE TSN devices or switches. Passive components such as connectors connecting cables are not included in the device and are considered part of the wiring.) In the ANSI/TIA/EIA-568-B standard which specifies the wiring specifications, the wiring between devices is called a channel. Assuming a state of combining cables and connectors, the transmission characteristics of the channel are specified apart from the transmission characteristics of the connector alone.

In the example in Figure 3.2-1, there are five channels in total connecting the devices, the wiring length of each channel is 100 m or less, and each channel is required to satisfy the transmission characteristics specification.

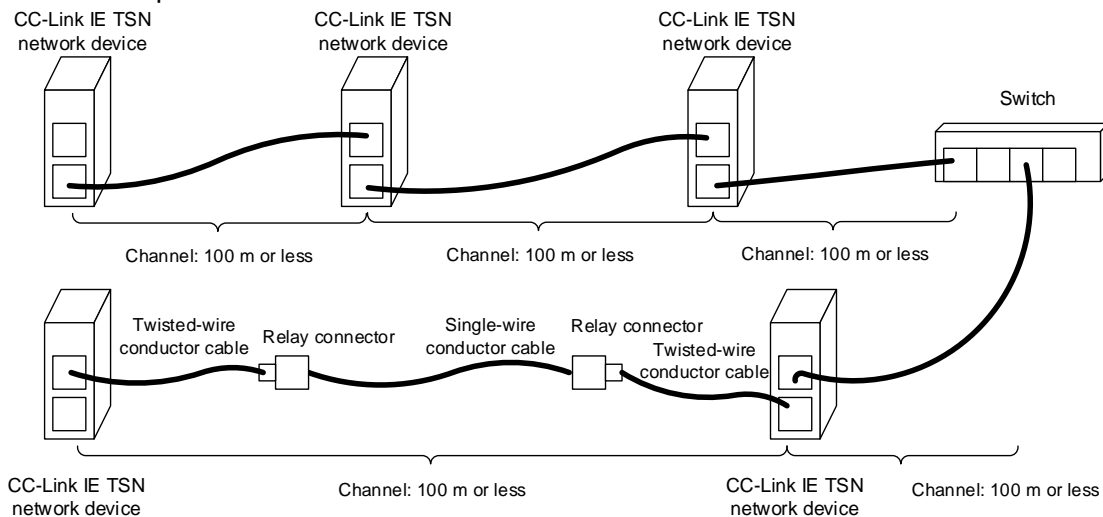

Figure 3.2-1 Wiring length

Wiring between devices, that is, the transmission characteristics of each channel must satisfy the channel specification value. Depending on the type of cable and the ambient temperature, it may not be possible to extend the wiring up to 100 m. In particular, the total amount of insertion loss and propagation delay of the wiring ports (cables, connectors) used needs to be the specification value of the channel or less. For details, refer to 3.2.4. Transmission characteristics.



In particular, use care with regard to the following cases.

- For twisted-wire conductor cables

Generally, twisted-wire conductor cable has a large insertion loss and may not satisfy the insertion loss specification of the channel when the wire is extended 100 m.

\* In Category 5e of ANSI/TIA/EIA-568-B, the specification value of the channel is specified by assuming the state of a combination of a 90 m single-wire conductor cable and 10 m twisted-wire conductor cable. Since the insertion loss of the twisted-wire conductor cable is larger than that of the single-wire conductor cable, the transmittable distance becomes shorter. For details, check with the cable manufacturer.

When wiring a long distance, use a single-wire conductor cable.

- When the conductor size is thin

Generally, when the conductor is thinner than 24 AWG (0.5 mm), the insertion loss is large and the transmittable distance becomes short.

- For special cables, such as for moving sections

Before use, check the transmission characteristics (especially insertion loss and propagation delay) and the transmittable distance indicated by the cable manufacturer.

- When multiple cables are connected

For example, if a device is installed inside the panel and short cables are used in the panel, the cable length, insertion loss, and propagation delay inside the panel also need to be taken into account. In addition, when connecting multiple cables using a relay connector (jack - jack) or the like, it is necessary to take into consideration insertion loss and propagation delay of all cables and connectors between the devices.

- When the ambient temperature is high

The maximum length between devices varies depending on the temperature environment (cable installation environment). Decide the cable length between devices based on Table 3.2-1. For details, calculate the insertion loss between devices according to "3.2.4. Transmission characteristics" and confirm that it is within the specified value.

The higher the temperature, the larger the insertion loss of the cable and the shorter the transmittable distance becomes. As an example of typical shielded cables, insertion loss increases by about 0.2% per 1°C. The specified insertion loss value of the cable is usually based on at 20°C. When the cable becomes hot even partially, it is necessary to satisfy the specified insertion loss in the state where the temperature has risen.

Also, if there is no margin to the channel specification value at 20°C, there is a risk of exceeding the specified insertion loss value due to changes in the ambient temperature. Calculate the insertion loss of cable at high temperature based on the temperature coefficient specification of the cable manufacturer.

Table 3.2-1 Temperature environment and maximum length between devices (example)

Cable ambient temperature (°C)	Maximum cable length [m]	Maximum length between cables [m] (channel including patch cord in Figure 3.2-2)
20	90.0	100.0
25	89.5	99.5
30	88.5	98.5
35	87.7	97.7
40	87.0	97.0
45	86.5	96.5
50	85.5	95.5
55	84.7	94.7
60	83.0	93.0

Reference Standard (ANSI/TIA/EIA-568-B.2-1 Annex G)

Condition) Table 3.2-1 assumes a channel that includes a 10 m patch cord or device cords (in a 20°C environment), as shown in Figure 3.2-2.

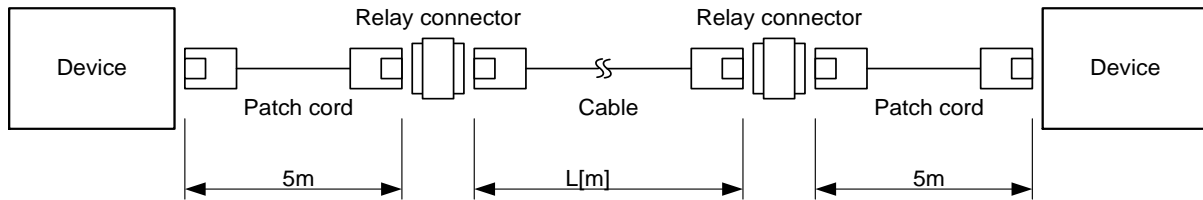

Figure 3.2-2 Temperature environment and channel configuration

### 3.2.2. Number of connectors

The number of connectors in one channel shall be four or less. However, confirm the following conditions.

- Plugs connected to the device at both ends of the channel are not counted. One plug and jack pair where cables are relayed is counted as one and make sure that the number of connectors is four or less.

If a relay connector (jack-jack) is used, calculate by assuming that the number of connectors is two with one relay connector.

### 3.2.3. Precautions on connectors and cable connections

If wiring processing is insufficient, communication failure occurs easily due to deterioration of the waterproof performance of M12 connectors, poor contact between the cable and connector, and other reasons. Therefore, follow the processing procedure specified by the connector manufacturer and work with due care.

#### 3.2.3.1. RJ45 connector

When connecting cables and connectors (plug/jack), follow the wiring method specified in the ANSI/TIA/EIA-568 standard and the wiring method/work procedure specified by the connector manufacturer.

In the ANSI/TIA/EIA-568 standard, the following T568A and T568B wiring patterns are specified. Other wiring methods can cause miswiring and there is a high risk of communication failure because the prescribed transmission characteristics cannot be obtained.

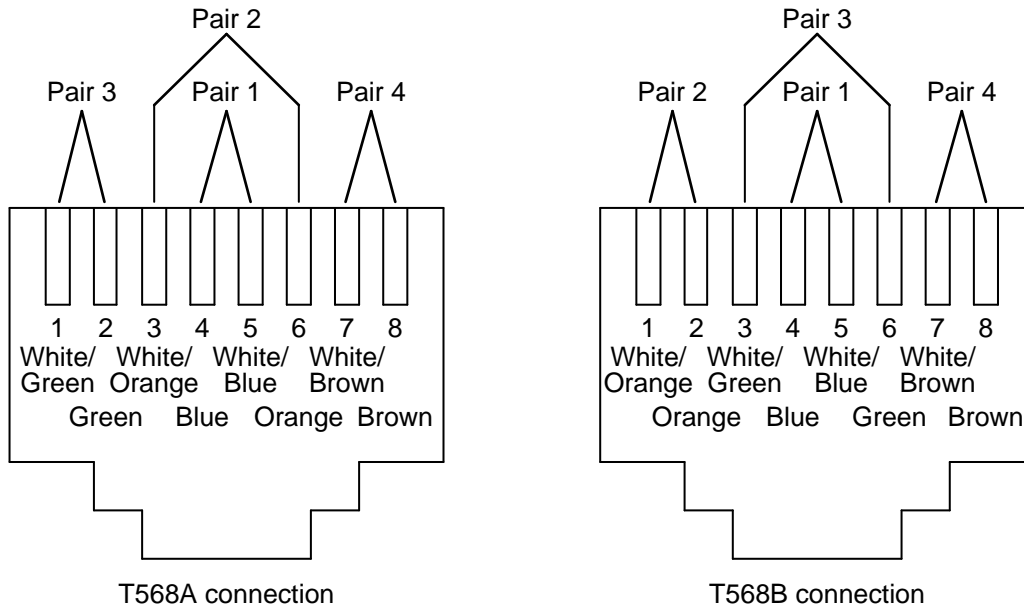

Figure 3.2-3 Connection to RJ45 Connector (Plug)

Unless otherwise specified, it is recommended to use the same connection (straight cable) at both ends of the cable. Pair 1 and 4 are NC in a cable whose number of core wires is 4-wire (2 twisted pairs).

### 3.2.3.2. M12 connector

Refer to the chart below for the wiring method used with M12 connectors (X-Coding) compliant with the IEC 61076-2-109 standard.

Be aware that the RJ45 connector and M12 connector are somewhat different in terms of the connection pin arrangement.

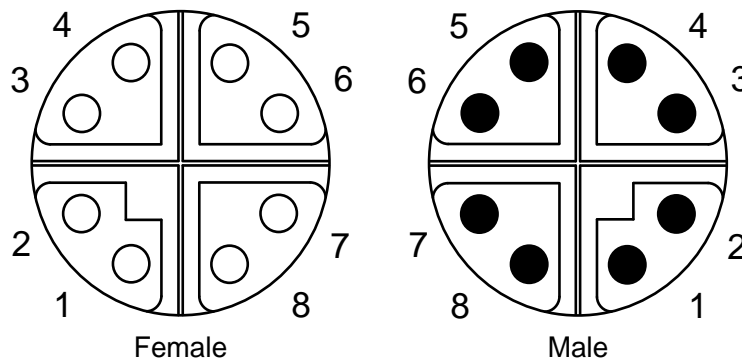

Figure 3.2-4 M12 (X-coding) connector

Table 3.2-2 Comparison table for connection method used with an M12 (X-coding) connector (RJ45/M12)

Cable color scheme (T568A)	Cable color scheme (T568B)	RJ45 connection Pin No.	M12 (X-Coding) connection Pin No.
White/Green	White/Orange	1	1
Green	Orange	2	2
White/Orange	White/Green	3	3
Blue	Blue	4	8
White/Blue	White/Blue	5	7
Orange	Green	6	4
White/Brown	White/Brown	7	5
Brown	Brown	8	6

Refer to the chart below for the wiring method used for M12 connectors (D-Coding) compliant with the IEC 61076-2-101 standard.

Be aware that the RJ45 connector and M12 connector are somewhat different in terms of the connection pin arrangement.

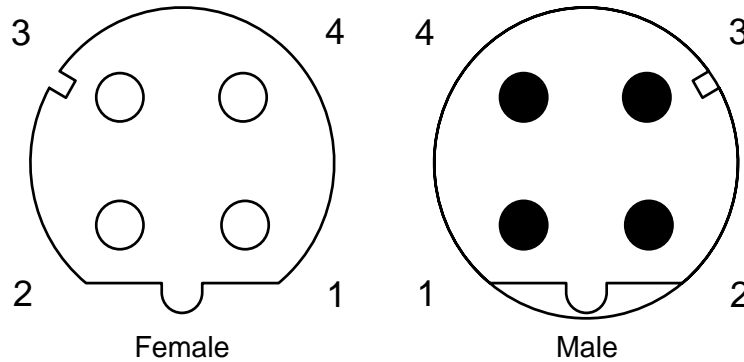

Figure 3.2-5 M12 (D-coding) connector

Table 3.2-3 Comparison table for connection method used with an M12 (D-coding) connector (RJ45T/M12)

Cable color scheme (T568A)	Cable color scheme (T568B)	RJ45 connection Pin No.	M12 (D-Coding) connection Pin No.
White/Green	White/Orange	1	1
Green	Orange	2	3
White/Orange	White/Green	3	2
Blue	Blue	4	NC
White/Blue	White/Blue	5	NC
Orange	Green	6	4
White/Brown	White/Brown	7	NC
Brown	Brown	8	NC

### 3.2.3.3. 10-pin rectangular connector (Compliant with IEC 61076-3-124, Type A)

When connecting a cable and a connector (plug/jack), follow the connection method defined in the IEC 61076-3-124 standard and the connection method and work procedure specified by the connector manufacturer.

The IEC 61076-3-124 standard specifies two connection methods, T568A and T568B, which are shown in the figure and table below. Any other connection method results in the risk of miswiring, increasing the possibility that the predetermined transmission characteristics will not be achieved and communications will fail.

For the connection method with this connector compliant with the IEC 61076-3-124 standard, refer to the figure and table below.

Note that the connection pin layout of this connector is slightly different from that of the RJ45 connector and M12 connector.

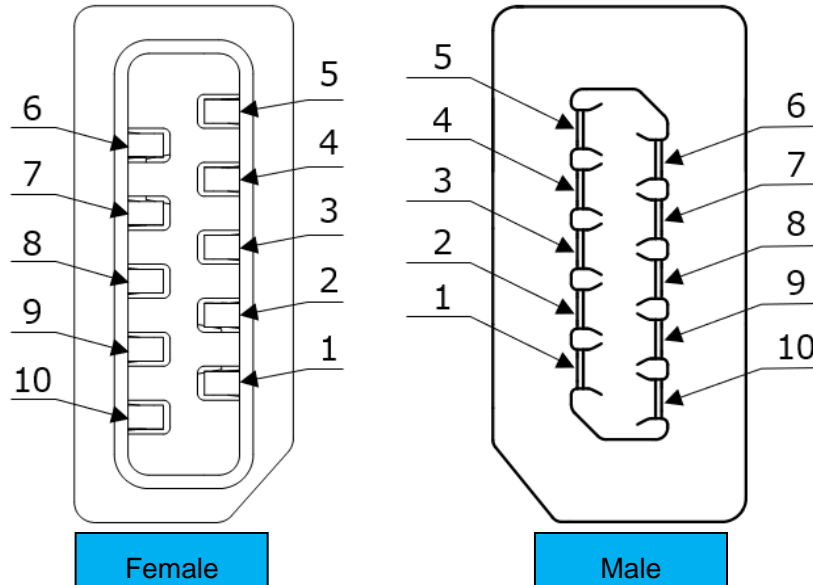

Figure 3.2-6 10-Pin Rectangular Connector (Compliant with IEC 61076-3-124, Type A)

Table 3.2-4 Comparison of the Connection Methods with the 10-Pin Rectangular Connector (RJ45/10-pin rectangular connector (Compliant with IEC 61076-3-124, Type A))

Cable color (T568A)	Cable color (T568B)	RJ45 connection pin number	10-pin rectangular connector (IEC 61076-3-124) connection pin number
White/Green	White/Orange	1	1
Green	Orange	2	2
White/Orange	White/Green	3	6
Blue	Blue	4	4
White/Blue	White/Blue	5	5
Orange	Green	6	7
White/Brown	White/Brown	7	9
Brown	Brown	8	10

\* There are 10 poles, however, pin numbers 3 and 8 are not connected.

### 3.2.3.4. Precautions on connector connection

If wiring processing is insufficient, communication failure occurs easily due to deterioration of the waterproof performance of M12 connectors, poor contact between the cable and connector, and other reasons. Therefore, follow the processing procedure specified by the connector manufacturer and work with adequate caution.

Make sure that the proper cable and connector combination are used in terms of the wire conductor size (AWG), conductor structure (single-wire, twisted-wire), external diameter of the insulator, external diameter of cable, shielding, category, and others.

- Cable conductor structure

Cables are classified into single-wire and twisted wire, and also connector types include single-wire, twisted wire, and the type for both wires. Therefore, check that the connection is appropriate.

Certain combinations cannot be used. For example, a single-wire cable cannot be combined with a connector for twisted wire.

Refer to Appendix "A1. Conductor Structure of Cable for FA".

- External diameter of cable

Check that the combination of cable external diameter and connector is appropriate.

If the external diameter range is not appropriate, there is a risk of breakage of the connector or a decrease in the cable retention strength.

- Shield and shielded line processing

In accordance with the treatment procedure of the connector manufacturer, connect the shield of the connector and the shield wire of the cable tightly.

- Pin terminal height (Crimp Height)

For RJ45 connectors of the type that push the pin terminal, it is important that the pin terminal height (crimp height) is uniform and within the specified value. Crimp height outside the specified value could cause communication failure.

Refer to Appendix "A2. Pin Terminal Height (Crimp Height)".

- Dedicated tool

Always use the special tools specified by the connector manufacturer, if any.

Failure to do so could cause incorrect wire connection.

Also, in some cases normal wiring cannot be performed due to deterioration or breakage of special tools. Therefore, perform periodic inspection of special tools.

- Reprocessing of connectors

Re-treatment of connector is not recommended.

If a connector is re-treated, communication errors may occur due to deformation or breakage of the connector.

### 3.2.4. Transmission characteristics

The wiring between devices must meet the transmission characteristic standard of the channel of the ANSI/TIA/EIA-568-B Category 5e standard. Even if wiring is performed using wiring materials (cables and connectors) that meet the Category 5e standard, if the construction method is inappropriate, the transmission characteristic standard of the channel may not be satisfied. When wiring is completed, it is recommended to use a field tester to measure and check whether the specification values are satisfied.

The main transmission characteristics specified in the Category 5e standard include the following items. Refer to the ANSI/TIA/EIA-568-B Category 5e standard for details of the specification values.

- Insertion loss (IL)
- Near end crosstalk (NEXT)
- Power sum near end crosstalk (PSNEXT)
- Equal level far end crosstalk (ELFEXT)
- Power sum equal level far end crosstalk (PSELFEXT)
- Return loss (RL)
- Propagation delay
- Delay skew

Of the above, insertion loss and propagation delay can be roughly calculated from the specification values of the cable and the connectors used for wiring. In particular, when using the cable at a length close to the standard upper limit of 100 m, if using a special cable such as a cable for movable parts or a cable with a small conductor size, or if using a cable under an environment where the ambient temperature is particularly high, it is necessary to confirm beforehand whether the specification values of the channel are satisfied with the configuration to be wired and the ambient temperature.

If on calculation it does not satisfy the specification values of the channel, to meet the channel specification values review the layout and shorten the total length of the wiring, shorten as short as possible the length of wiring that uses a cable with a small conductor size or a cable for a movable part, or use cables with a smaller insertion loss or propagation delay, and others. If this is not possible, consider inserting a switch or the like in the middle.

Also, for items other than insertion loss and propagation delay, it is impossible to calculate easily from the cable/connector specification value, and it is necessary to measure using items such as a field tester.

- Rough estimation of delay time

When two types of cables are used and connected using multiple connectors (plug + jack)

Propagation delay at 10 MHz per 100 m of cable 1:  $\text{Delay}_{\text{cable1}}$  (ns/100 m)

(Usually, 545ns/100 m or less.)

Propagation delay at 10 MHz per 100 m of cable 2:  $\text{Delay}_{\text{cable2}}$  (ns/100 m)

Total length of cable 1 and cable 2:  $L_{\text{cable1}}$ ,  $L_{\text{cable2}}$  (m)

Propagation delay of the connector (plug + jack):  $\text{Delay}_{\text{conn}}$  (ns) (Usually, 2.5 ns or less.)

Calculate using 2.5 ns.)

Number of connectors: n

Propagation delay of channel (wiring between devices):  $\text{Delay}_{\text{channel}}$  (ns)

$$\text{Delay}_{\text{channel}} = \text{Delay}_{\text{cable1}} \times L_{\text{cable1}} / 100 + \text{Delay}_{\text{cable2}} \times L_{\text{cable2}} / 100 + \text{Delay}_{\text{conn}} \times n \quad \text{(Formula A)}$$

Confirm that the channel propagation delay obtained above is not more than the channel specification value (555 ns).

The following shows an example calculation when using a combination of a single-wire conductor cable (cable 1) and a special cable with a large propagation delay (cable 2).

Propagation delay at 10 MHz per 100 m of cable 1:  $\text{Delay}_{\text{cable1}} = 545$  (ns/100 m)

Propagation delay at 10 MHz per 100 m of cable 2:  $\text{Delay}_{\text{cable2}} = 600$  (ns/100 m)

Propagation delay of connectors (plug + jack):  $\text{Delay}_{\text{conn}} = 2.5$ (ns)

Number of connectors: n = 4

Propagation delay of channel (wiring between devices):  $\text{Delay}_{\text{channel}}$  (ns)

$$\text{Delay}_{\text{channel}} = 545 \times L_{\text{cable1}} / 100 + 600 \times L_{\text{cable2}} / 100 + 2.5 \times 4$$

Example 1: When the total length of cable 1 and cable 2 is 80 m and 3 m, respectively,

$$\text{Delay}_{\text{channel}} = 545 \times 80 / 100 + 600 \times 3 / 100 + 10 = 464 \text{ (ns)}$$

Since the propagation delay specification value 555 ns of the channel is satisfied, this layout can be used.

Example 2: When the total length of cable 1 and cable 2 is 40 m and 60 m, respectively,

$$\text{Delay}_{\text{channel}} = 545 \times 40 / 100 + 600 \times 60 / 100 + 10 = 588 \text{ (ns)}$$

Since the propagation delay specification value 555 ns of the channel is not satisfied, this layout cannot be used.

The propagation delay of the channel is designed to be 555 ns, which is the specification value of the channel, when a total of 100 m of cable that satisfies the propagation delay (545 ns/100 m) prescribed in the ANSI/TIA/EIA-568-B Category 5e standard is used and connectors (propagation delay 2.5 ns) are used in four locations. Therefore, calculation of the propagation delay is unnecessary when a special cable with a large propagation delay is not used.



- Rough estimation of insertion loss

When two types of cables are used and connected using multiple connectors (plug + jack)

Insertion loss per 100 m of cable 1:  $IL_{cable1}$  (dB/100 m)

Insertion loss per 100 m of cable 2:  $IL_{cable2}$  (dB/100 m)

Total length of cable 1 and cable 2:  $L_{cable1}$ ,  $L_{cable2}$  (m)

Insertion loss of connector (plug + jack):  $IL_{conn}$  (dB)

Number of connectors: n

Insertion loss of channel (wiring between devices):  $IL_{channel}$  (dB)

$IL_{channel} = IL_{cable1} \times L_{cable1}/100 + IL_{cable2} \times L_{cable2}/100 + IL_{conn} \times n \dots$  (Formula B)

Temperature conversion formula of cable insertion loss

Insertion loss per 100 m of cable 1 at 20°C:  $IL_{cable1, 20^\circ C}$  (dB/100 m)

Temperature coefficient of insertion loss of cable 1:  $k_{cable1}$  (%)

Cable temperature: t (°C)

Insertion loss per 100 m of cable 1 at t (°C):  $IL_{cable1, t^\circ C}$  (dB/100 m)

$IL_{cable1, t^\circ C} = IL_{cable1, 20^\circ C} \times (1 + (t-20) \times k/100) \dots$  (Formula C)

Therefore, when calculating the insertion loss of the channel at t°C, instead of using Formula B,  $IL_{cable1}$ ,  $IL_{cable2}$ , use  $IL_{cable1, t^\circ C}$ ,  $IL_{cable2, t^\circ C}$  of Formula C.

Confirm that the channel propagation delay obtained above is the channel specification value or less. Originally it is necessary to meet the channel specification value in the whole band of 1 MHz to 100 MHz. However, as a rough judgment method, it can usually be judged by insertion loss at 100 MHz.

The following shows a calculation example where a combination of a single-wire conductor cable (cable 1) and a twisted-wire conductor cable (cable 2) is used and the ambient temperature rises up to 60°C.

Insertion loss per 100 m of cable 1 at 20°C:  $IL_{cable1, 20^\circ C} = 22.0$  (dB/100 m)

Temperature coefficient of insertion loss of cable 1:  $k_{cable1} = 0.2$  (%)

Insertion loss per 100 m of cable 2 at 20°C:  $IL_{cable2, 20^\circ C} = 26.4$  (dB/100 m)

Temperature coefficient of insertion loss of cable 2:  $k_{cable2} = 0.2$  (%)

Cable temperature: t = 60 (°C)

Insertion loss of connector (plug + jack) at 100 MHz:  $IL_{conn} = 0.4$  (dB)

Number of connectors: n = 4

Insertion loss of channel (wiring between devices) at 100 MHz:  $IL_{channel}$  (dB)

$$IL_{channel} = (22.0 \times (1 + (60-20) \times 0.2/100)) \times L_{cable1}/100 + (26.4 \times (1 + (60-20) \times 0.2/100)) \times L_{cable2}/100 + 0.4 \times 4$$

$$= 23.76 \times L_{cable1}/100 + 28.51 \times L_{cable2}/100 + 1.6$$

Example 1: When the total length of cable 1 and cable 2 is 80 m and 3 m, respectively,

$IL_{channel} = 23.76 \times 80/100 + 28.51 \times 3/100 + 1.6 = 21.46$  (dB)

Since the insertion loss specification value 24 dB of the channel at 100 MHz is satisfied, this layout can be used.

Example 2: When the total length of cable 1 and cable 2 is 50 m and 40 m, respectively,

$IL_{channel} = 23.76 \times 50/100 + 28.51 \times 40/100 + 1.6 = 24.88$  (dB)

Since the insertion loss specification value 24 dB of the channel at 100 MHz is not satisfied, this layout cannot be used.

Note that the above is only a rough judgment method and for various reasons it does not necessarily agree with the actual measured value of channel insertion loss. For the insertion loss specification, set the cable length with a margin. Also, after wiring, it is recommended to use a measuring instrument such as a field tester to measure under the actual measuring conditions to confirm that there is a margin.

## 3.3. Installation and Wiring

### 3.3.1. Precautions on installation

- Installation route
  - Use ducts or cable racks as much as possible in the installation route.
  - In the case of a pipeline such as a conduit, select the pipe diameter considering the dimensions of connectors, boots, and others. Also, when providing a pull box in the middle of a pipeline, select one that satisfies the allowable bending radius of the cable.
  - Use a dedicated installation route as much as possible.
  - The route should be free of water and oil intrusion, and high/low temperatures outside the applicable ambient temperature.
  - When constructing an installation route with a special environment inside a factory, select environmentally friendly materials.  
Example: Heat resistance, oil resistance, movable parts, and others
  - For environmental resistance of each material, refer to the specifications of each manufacturer.
  
- Cable minimum bending radius
  - Confirm the specifications of each cable manufacturer and use the cable by adhering to the minimum bending radius.
  - The minimum bending radius is the radius that can guarantee the characteristics over a long period of time after fixing the cable.
  - If you are forced to use a cable below the minimum bending radius, there is a risk that the transmission performance may deteriorate or the cable may be broken.
  
- Allowable tension
  - To the extent possible, do not apply tension to the cable.
  - There is a risk that the connector may come out, breaking the cable or causing inability to satisfy the transmission performance.
  - At installation: When it is unavoidable that tension will be applied, use within the allowable tension of the cable.  
(Confirm with the cable manufacturer.)
  - When fixing: Pay attention to the wiring length/fixing method so as not to apply tension to the cable.
  
- Notes on noise countermeasures
  - In order to prevent induced noise, lay the power line and signal line as far apart as possible.
  - Do not lay the cable in a panel where high pressure devices are installed.
  - Attach a surge suppressor to a high noise device.
  
- Cable side pressure
  - Do not apply side pressure through too much packing or pinching of cables to/with cable protective materials such as wire protectors or pipe, or excessive tightening of the cable ties.
  - It may become unable to satisfy the transmission performance.
  
- Handling of connectors
  - Before connecting, be careful not to apply external force such as side pressure or impact the connector.
  - In particular, both the metal part and plastic resin part of the terminal part of the RJ45 plug are easily deformed, so careful handling is required.
  - If connecting with a deformed connector, it could cause a malfunction or damage to the connection part on the device side due to a poor connection.
  - If there is a possibility that an external force has been applied to the connector, check for deformation before use.  
Refer to Appendix "A3. Deformation of Connectors".

- Stress on the connector connecting part
  - Make sure not to apply stress on the connector connecting part.
  - If stress is applied on the connector connecting part due to the weight of the cable, neck bending, twisting, shaking, transportation, or inadvertent pulling, it could cause breaking of the unit or connector, malfunctions due to poor connection, or communication failure that occurs over time.
  - Since the conductor of the single-wire conductor cable is hard, do not apply stress to the connector connecting part.  
Furthermore, when wiring a short distance, it becomes easy for stress to be applied to the connector connecting part.
  - When wiring a short distance, it is recommended to use a twisted-wire conductor cable or movable cable that is flexible and easy to handle.
- Waterproof performance of M12 connector
  - Refer to the manual of the unit and others.
- Wiring to movable parts
  - When wiring to a movable part, use a cable dedicated to the movable part.  
Also, in order to prevent early disconnection, pay attention to the following when wiring.
  - Check with the manufacturer about bending characteristics such as the minimum bending radius of the cable.
  - Do not bend, kink or twist the cable.
  - Do not damage the cable sheath.
  - Minimize cable fixing locations.
  - Do not forcefully fix the cable at a location where the cable moves.
  - Wire with the optimum length.
- Others
  - When performing connection of cables, make sure that the power supply and communication power supply of connected devices are all OFF.

### 3.3.2. Grounding method

- Grounding of each unit (grounding of FG) shall be dedicated grounding or common grounding.
- Grounding installation shall be D class grounding (3rd class grounding). (Grounding resistance: 100 Ω or less)

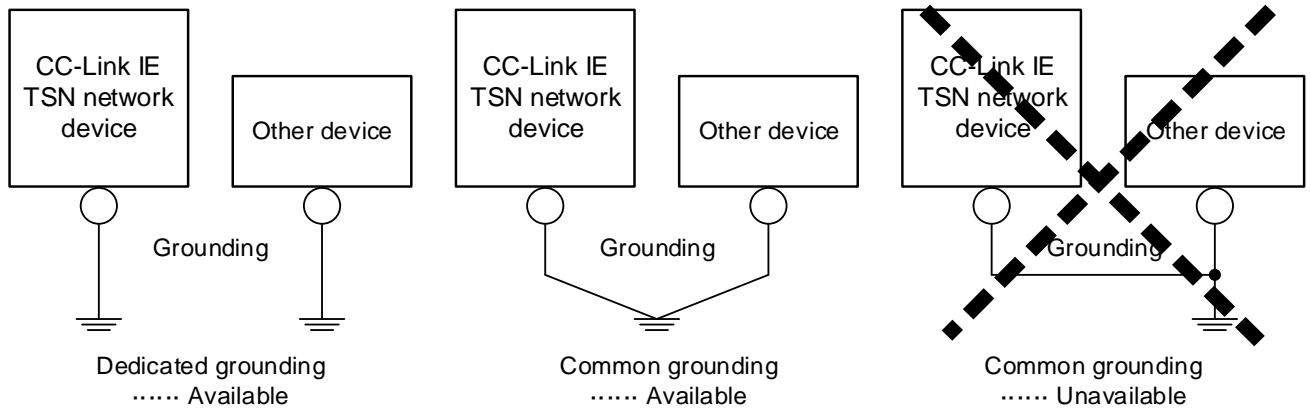

Figure 3.3-1 Grounding method

- Use as thick a wire as possible for the grounding wire (2 mm<sup>2</sup> or more). Also, make the distance between the grounding point and the sequencer as close as possible and shorten the grounding wire.

#### 3.3.2.1. Additional explanation about grounding

##### (1) Grounding types

When classifying grounding of CC-Link IE TSN compatible products (devices) by purpose, the types of grounding are roughly divided into two categories (Figure 3.3-2):

1. Protective grounding intended to protect people from electric shock and leakage
2. Functional grounding for securing communication reliability

The grounding of the shielded wire of the cable for CC-Link IE TSN is for functional grounding to secure the reliability of communication.

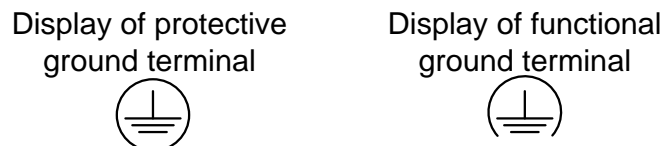

Figure 3.3-2 Display of grounding terminals

##### (2) Additional information about the grounding method

Protective grounding and functional grounding shall be dedicated grounding (Figure 3.3-3), or common grounding (Figure 3.3-4) where grounding wires are laid down individually up to the grounding point. For common grounding (Figure 3.3-5), noise can enter from the protective grounding to functional grounding and communication with CC-Link IE TSN can be unstable. In particular, if the protective grounding and the functional grounding (the shielded wire of the cable for CC-Link IE TSN) of driving devices such as inverters and servos are commonly grounded, the possibility of unstable communication increases.

- 1) Use copper wire of 1.6 mm or more diameter, or 2 mm<sup>2</sup> or more for the grounding wire of functional grounding.

(For the grounding wire to the grounding point, it is recommended to use a thick copper wire (14 mm<sup>2</sup> or more is recommended) and lay it as short as possible.)

- 2) Do not lay the grounding wire of the functional grounding in a bundle with the protective grounding wire or power line.  
 (It is possible that noise could enter the grounding wire and communication could become unstable.)

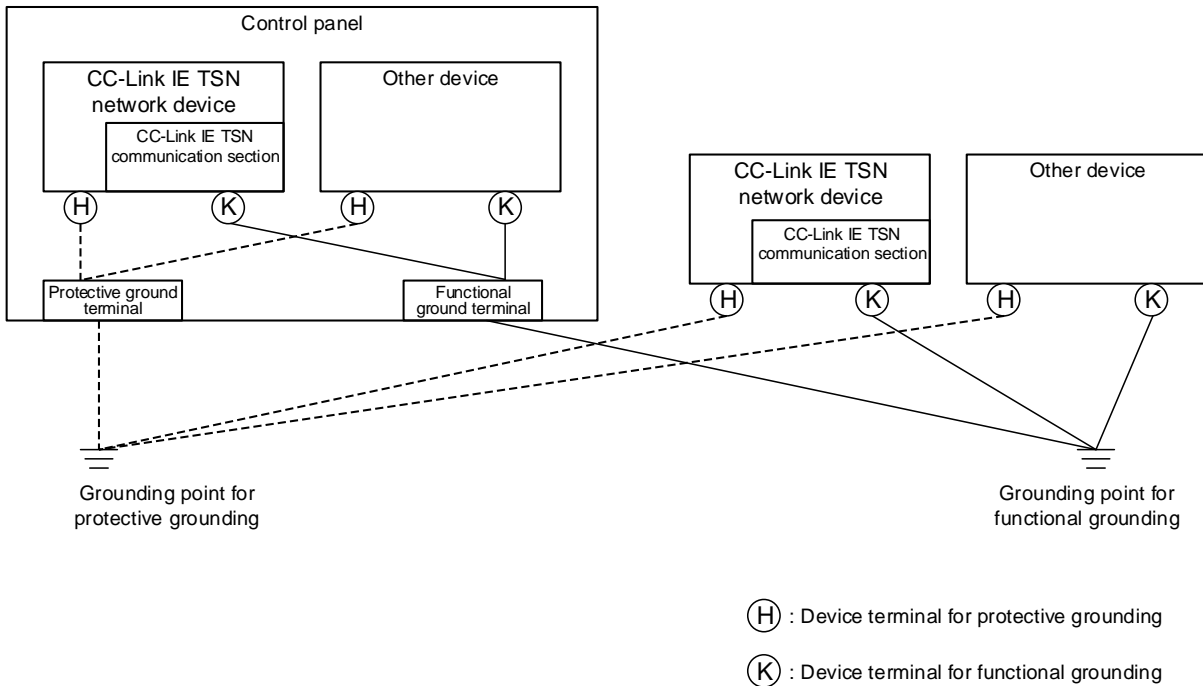

Figure 3.3-3 Example of dedicated grounding

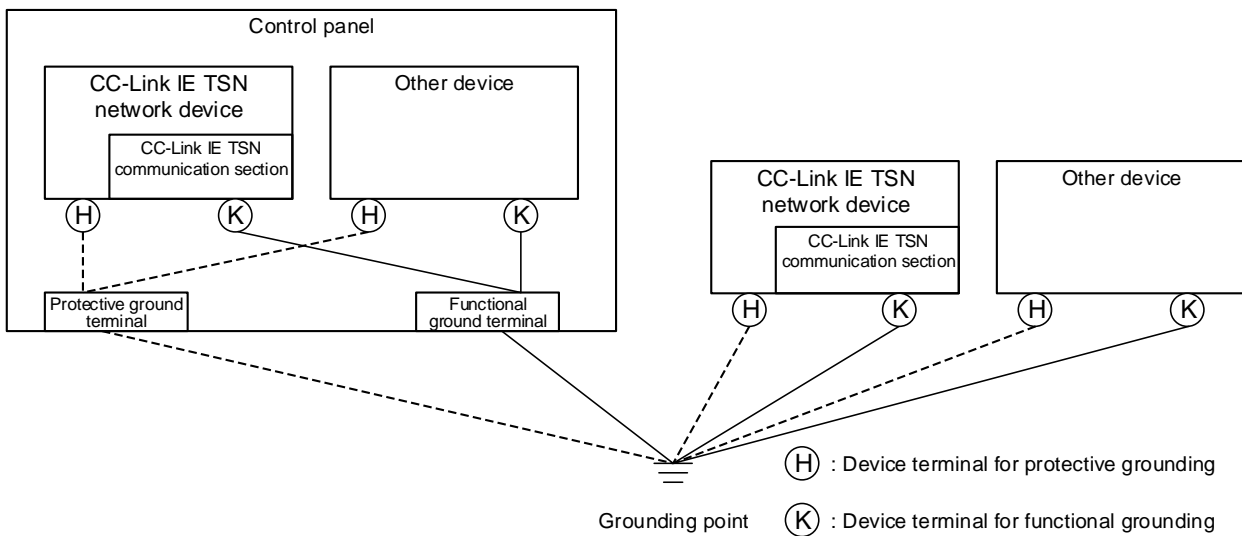

Figure 3.3-4 Example of Common Grounding

## Next-generation CC-Link IE network device

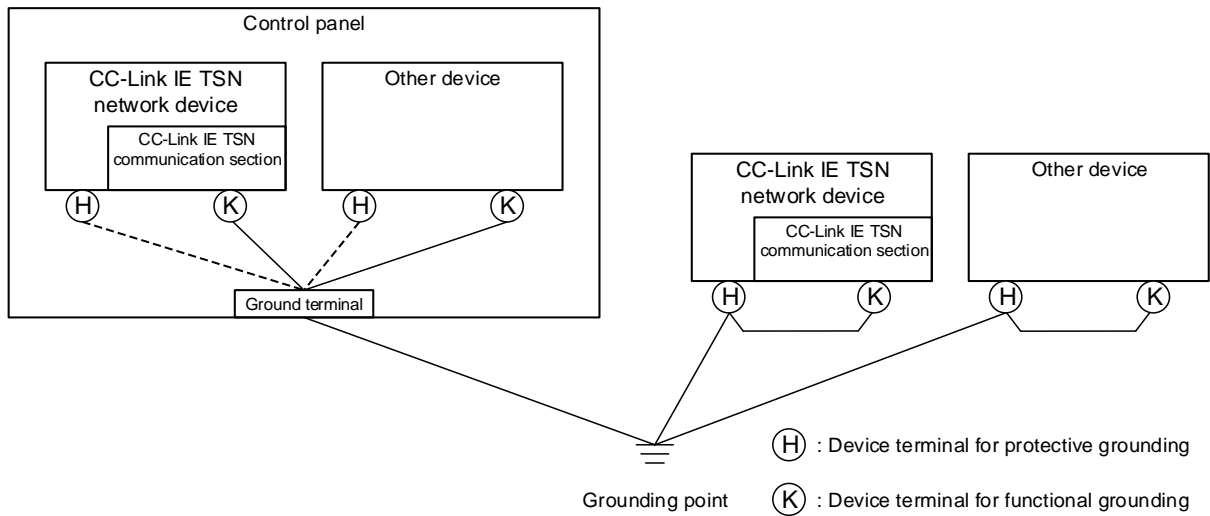

Figure 3.3-5 Example of Common Grounding

### (3) Wiring example of common grounding

A wiring example of common grounding is shown in Figure 3.3-6.

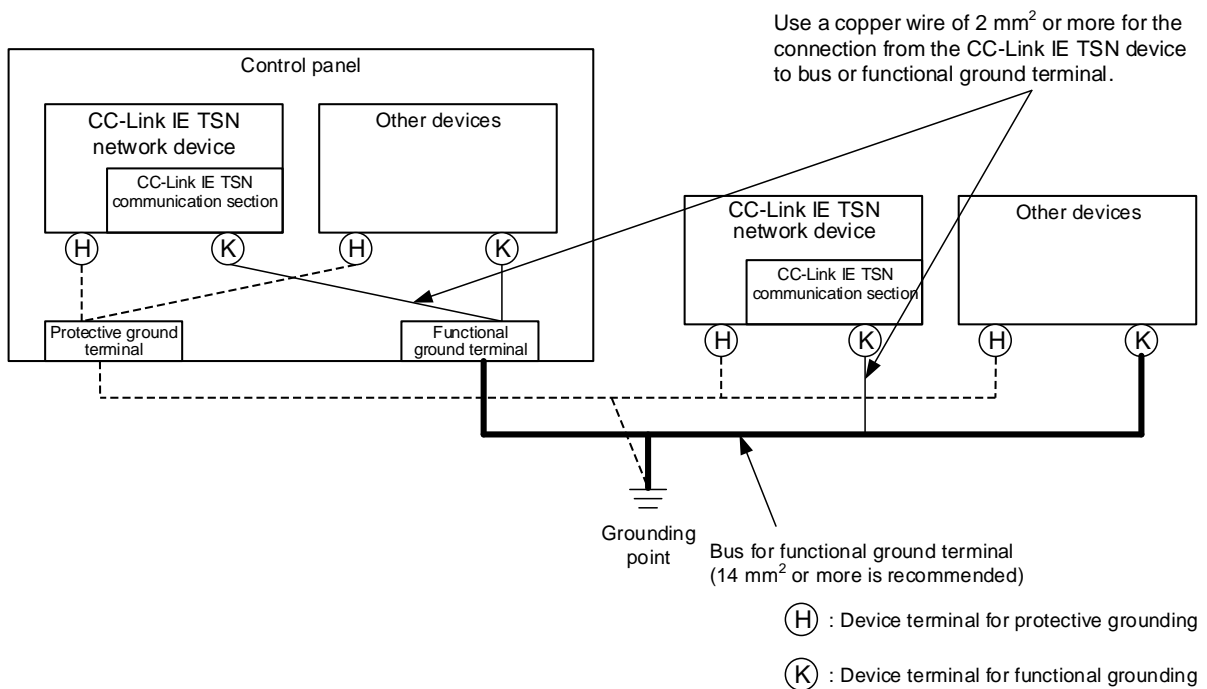

Figure 3.3-6 Wiring example of common grounding

## 4. OPTICAL FIBER CABLE

### 4.1. 1 Gbps (Optical)

#### 4.1.1. Selecting devices to be connected

##### 4.1.1.1. Optical fiber cable

For CC-Link IE TSN, it is recommended to use the optical fiber cable recommended by CLPA that is used for a CC-Link IE controller network compliant with IEC.

Typical specification is shown in Table 4.1.1-1.

Table 4.1.1-1 Optical fiber specifications

No.	Item	Specifications	
1	Optical fiber type	1000BASE-SX compatible multi-mode GI type optical fiber	1000BASE-SX compatible GI type optical fiber (GI-POF)
2	Compliant standard	IEC 60793-2-10 Types A1a.1	IEC 60793-2-40 under proposal
3	Core	Material	Quartz glass
		External diameter	50±3 μm
4	Clad	Material	Quartz glass
		External diameter	125±2 μm
5	Primary coating layer	External diameter	0.25 mm
6	Secondary coating layer	External diameter	0.9±0.1 mm
7	Cord	External diameter	2.0±0.2 mm × 2 cords (2.0 × 4.0 mm)
8	Use temperature	-20 to 60°C	-20 to 60°C
9	Allowable bending radius	15 mm (after installation)	10 mm (after installation)
		30 mm (during installation)	10 mm (during installation)
10	Transmission loss	3.5 (dB/km) or less (λ = 850 nm)	100 (dB/km) or less (λ = 850 nm)
11	Transmission band	500 (MHz/km) or higher (λ = 850 nm)	350 (MHz/km) or higher (λ = 850 nm)

##### 4.1.1.2. Optical connector

For CC-Link IE TSN, it is recommended to use the optical connector recommended by CLPA that is used for a CC-Link IE controller network compliant with IEC.

Typical specification is shown in Table 4.1.1-2.

Table 4.1.1-2 Optical connector specifications

No.	Item	Specifications	
1	Optical connector type	1000BASE-SX compatible multi-mode GI type optical fiber	1000BASE-SX compatible GI type optical fiber (GI-POF)
2	Compliant standard	IEC 61754-20: Type LC connector	IEC 61754-20: Type LC connector
3	Insertion loss	0.3 (dB) or less (for master fiber)	-
4	Return loss	20 dB or higher	-
5	Polishing method	PC polishing	-

## 4.1.2. Checking wiring

### 4.1.2.1. Wiring length

In the CC-Link IE TSN specification, the maximum physical wiring length between nodes is 550 m for 1000 Mbps multimode fiber, and 50 m for plastic optical fiber cable (POF).

The line loss between nodes needs to be within the recommended line loss value. For details, refer to "4.2.4 Transmission characteristics".

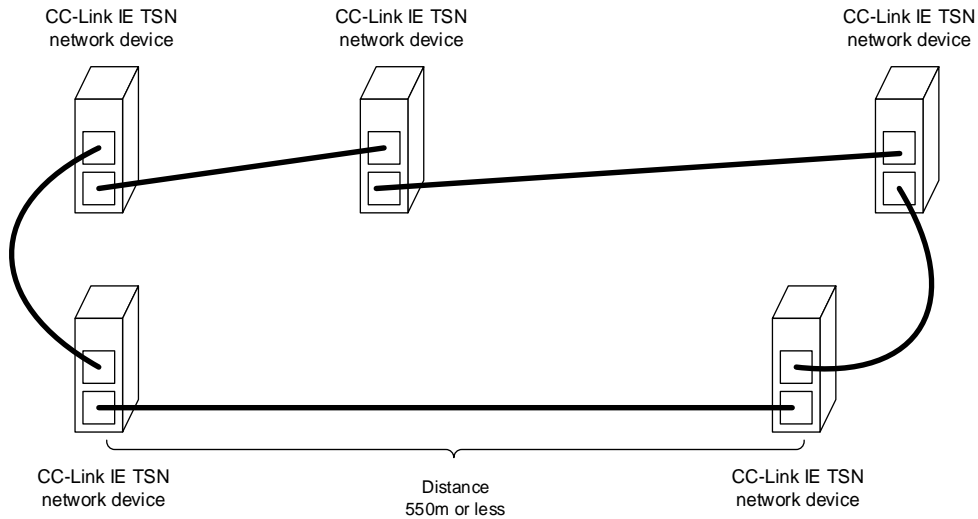

Figure 4.1.2-1 Wiring length

### 4.1.2.2. Number of connectors

The line loss needs to be within the recommended line loss value. For details, refer to "4.1.2.4 Transmission characteristics".

### 4.1.2.3. Precautions on connectors and cable connections

In accordance with the processing procedure specified by the connector manufacturer, work with due care when performing connection. For details, refer to "4.1.3 Installation and wiring".



### 4.1.2.4. Transmission characteristics

When installing the optical cable, check that the line loss between the nodes is within the recommended line loss value.

For 1000BASE-SX compatible multimode and plastic optical fiber cable (POF), check based on the following calculation as an example.

- Calculation of line loss value

(1) For 1000BASE-SX compatible multimode GI type fiber

Based on the following formula, calculate the line loss value and confirm that it is within the recommended line loss value (4.5 dB).

Line loss value (dB) =

Optical fiber cable transmission loss specification value (dB/km) × Optical fiber cable length (km) ... 1)

+ Connection loss value (dB/location) × Number of connections ... 2)

+ Adapter connection loss value (dB/location) × Number of adapter connections (location) ... 3)

1) Optical fiber cable transmission loss specification value (dB/km)

: Based on the optical fiber cable specifications.

2) Fusion splicing loss value (dB/location)

: 0.2 dB or less/location

3) Connector adapter connection loss value (dB/location)

: Depends on the optical connector type or manufacturer.

**Line loss value (dB) ≤ 4.5 (dB)** ... CLPA recommended value

[Calculation example]

Condition • GI type optical fiber (transmission loss value: 3.5 dB/km) • Total cable length: 550 m

Table 4.1.2-1 Example of connector adapter connection loss

Connector type	Number of cores	Polishing type	Optical fiber type		Remarks
			SM (dB or less)	GI (dB or less)	
SC	Single-core	PC polishing	0.7	0.4	Reference value
LC			0.5	0.3	

Note) Since the above values differ depending on the manufacturer, contact the adapter manufacturer for details.

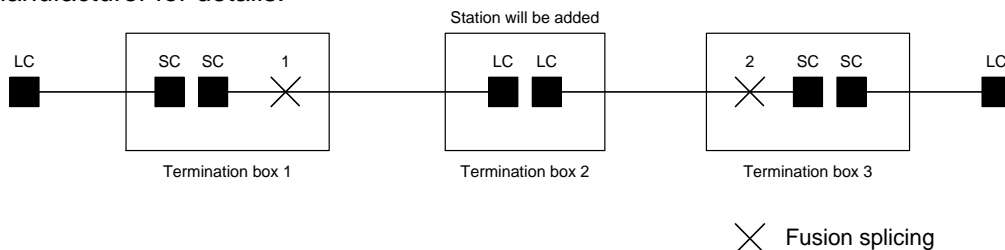

Figure 4.1.2-2 Connection example

1) Cable transmission loss    2) Fusion splicing loss    3) Connector adapter connection loss

$$\begin{aligned}
 \text{Line loss value (dB)} &= (3.5 \text{ dB/km} \times 0.55 \text{ km}) + (0.2 \text{ dB} \times 2 \text{ locations}) + (0.4 \text{ dB} \times 2 \text{ locations} \\
 &\quad + 0.3 \text{ dB} \times 1 \text{ location}) \\
 &= 3.425(\text{dB})
 \end{aligned}$$

(2) For plastic optical fiber cable (POF)

Based on the following formula, calculate the line loss value and confirm that it is within the recommended line loss value (15 dB).

$$\begin{aligned} \text{Line loss value (dB)} &= \text{Optical fiber cable transmission loss specification value (dB/km)} \times \text{Optical fiber cable length (km)} \quad \dots 1) \\ &+ \text{Connection loss value (dB/location)} \times \text{Number of connections} \quad \dots 2) \\ &+ \text{Connector adapter connection loss value} \quad \dots 3) \end{aligned}$$

- 1) Optical fiber cable transmission loss specification value (dB/km)  
: Based on the optical fiber cable specifications.
- 2) Connection loss value (dB/location) : Depending on the connector specification.
- 3) Connector adapter connection loss (dB/location)  
: 0.5 dB

**Line loss value (dB) ≤ 15(dB)**

... CLPA recommended value

[Calculation example]

Condition • Fiber transmission loss value: 100 dB/km • Total cable length: 50 m • Connection loss: 2 dB/location 2 locations

$$\begin{aligned} \text{Line loss value (dB)} &= \underbrace{(100 \text{ dB/km} \times 0.05 \text{ km})}_{\text{1) Cable transmission loss}} + \underbrace{(2 \text{ dB} \times 2 \text{ locations})}_{\text{2) Fusion splicing loss}} + \underbrace{0.5 \text{ dB}}_{\text{3) Connector adapter connection loss}} \\ &= 9.5 \text{ (dB)} \end{aligned}$$

• Line loss measurement method

According to the following procedure, measure the line loss between nodes and check that the measured value is within the line loss value calculated in "4.1.2.4Transmission characteristics".

(1) Measurement of optical input pin (Reference emitted light; Measured cable incident light)

- 1) Connect the exciter (mode scrambler) to the light source.
- 2) Set the wavelength of the light source to 850 nm.
- 3) Connect the exciter to the power meter, set the measurement mode to dBm mode, set the wavelength to 850 nm, and measure Pin [dBm].

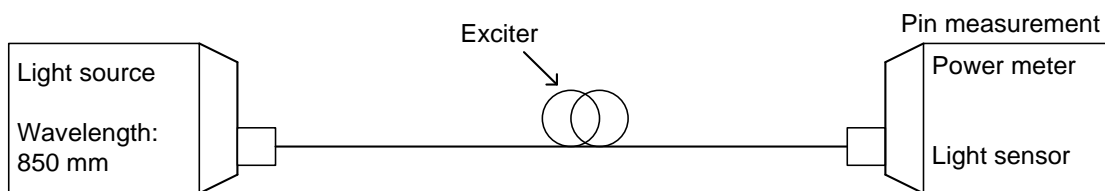
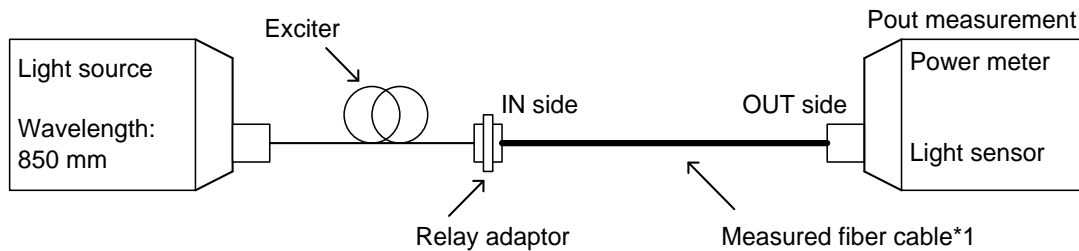

Figure 4.1.2-3 Measurement configuration of optical input pin

(2) Measurement of light output Pout (measured cable emitted light)

- 1) Connect the relay adaptor and the optical fiber cable to be measured to the exciter.
- 2) In dBm mode, measure Pout [dBm]. (Wavelength: 850 nm)



\*1 This figure shows all adaptor connection and fusion splicing locations.  
(Includes all the connections between nodes.)

Figure 4.1.2-4 Measurement configuration of light output Pout

(3) Line loss value Px[dB]

$P_x[\text{dB}] = P_{in}[\text{dBm}] - P_{out}[\text{dBm}] - P_c[\text{dB}]$  (Adapter connection loss portion at connection with exciter)

(4) Others

Because CC-Link IE TSN uses 2-core optical fiber cables, measure another core wire in the same way.

Recommended power meter: Photom205A made by Graytechnos Co., Ltd.

### 4.1.3. Installation and wiring

#### 4.1.3.1. Precautions on installing cable

##### 4.1.3.1.1. Installation

When installing optical cables, make sure to observe the following precautions.

- Installation route
  - Use pits, ducts or cable racks as much as possible in the installation route.
  - In the case of a pipeline such as a conduit, select the pipe diameter while taking the dimensions of the connector and others into consideration. Also, when providing a pull box in the middle of a pipeline, select one that satisfies the allowable bending radius of the cable.
  - Use a dedicated installation route as much as possible. When sharing with other cables, lay the optical fiber cable last.
  - The route should be free of water and oil intrusion, and high/low temperatures outside the applicable ambient temperature.
- Pipeline
  - Do not directly draw the cable; instead fix it to a cable-extending rope and lay it. Depending on the structure, some cables can be drawn directly so check with the manufacturer.
  - Confirm the specifications of each cable manufacturer and use the cable by adhering to the minimum bending radius.
  - The minimum bending radius is the radius that can guarantee the characteristics over a long period of time after fixing the cable.
  - If you are forced to use a cable below the minimum bending radius, there is a risk that the transmission performance may deteriorate or the cable may be broken.
- Precautions on extending lines
  - The pulling speed of the cable shall be 10 m/min or less and perform tip drawing. Also, extend the line under 1/2 or less allowable tension so that the tension applied to the cable is even.
  - The bending radius at the time of line extension should be at least twice the allowable bending radius.

- While installing, make sure not to twist the cable. In particular, since some hanger rollers have a structure that tends to cause twisting, it is recommended to use a metal wheel when installing a long cable.
- Be careful not to cause kinking (local bending) of the cable.
- Protection of allowable tension
  - When installing a cable vertically or in the case of aerial wiring, support so that the tension due to the weight of the cable itself does not exceed the allowable tension.
- Prevention of moisture infiltration
  - Generally, the optical fiber itself has poor water resistance and water infiltration from the end of the optical cable may have an adverse effect in the long term. Furthermore, in some cases, dew condensation caused by the temperature gradient of the optical cable installation route infiltrates inside the optical cable, which could adversely affect the cable. When installing an optical cable, make sure to provide waterproofing on the end of the optical cable.
  - POF cable is designed to be used indoors. Do not use it outdoors. In an environment where moisture infiltrates from the end of the POF cable, provide waterproofing on the POF cable end.
- Protection of the connector part
  - When installing a cable, do not bend the connector part and protect the part using a vinyl hose or a pulling eye. Also, the connector part is very weak to shock and tension, so do not pull it.
  - Before connecting, be careful not to apply external force such as side pressure or impact the connector.
  - Do not remove the protective cap of the optical connector until the connector is connected.
  - Do not touch the tip of the optical connector or bump it.
- Wiring to movable parts

When wiring to a movable part, use a cable dedicated to the movable part. Also, in order to prevent early disconnection, pay attention to the following when wiring.

  - Check with the manufacturer about bending characteristics such as the minimum bending radius of the cable.
  - Do not bend, kink or twist the cable.
  - Do not damage the cable sheath.
  - Minimize cable fixing locations.
  - Do not forcibly fix the cable at a location where the cable moves.
  - Wire with the optimum length.
- Others
  - For waterproofing purposes, seal both ends of the cable except during work.
  - Use care while handling because the tip of the optical fiber is sharp.
  - Do not touch the tip of the optical connector or bump it.
  - Since vinyl tape and binding bands containing migratory plasticizer may affect the optical characteristics of optical fiber, check beforehand for any such influence in the environment.
  - When side pressure or twist is applied to the optical fiber, the optical cable itself deforms, stress is applied to the internal optical fiber, transmission loss increases, as a result, the cable could break. Do not tighten the optical cable strongly using a nylon band (tie wrap) or the like as the same condition occurs when bundled.
  - When fixing the cable with a cable tie or the like, do not apply tension with the cable bent at the cable tie fixing part.
  - CLETOP-S (Type-B) made by NTT-AT is recommended for cleaning of the fiber tip.

#### 4.1.3.1.2. Fusion splicing and adapter connection

When performing fusion splicing, it is recommended to make a request to a specialized cable manufacturer.

When performing each connection, pay attention to the following items.

- Precautions on fusion splicing
  - Follow the procedure described in the instruction manual of the fusing machine (other tools) to be used. In addition, always observe precautions written in the manual.
  - Never fuse the core wire in a twisted state.
  
- Protection of connected locations
  - Set the fusion splicing and adapter connection locations using a termination box so that tension is not applied to the connection locations. Also, secure a space to install a termination box. The size increases as the number of connections increases. However, it is available from around 15 cm × 10 cm. Since a different termination box is used depending on the number of connections, the connection type, and the shape of the cable to be connected, contact the distributor of the optical fiber cable for details.
  
- Connection loss
  - Fusion splicing and adapter connections cause loss at the connection location. Read the contents of "4.1.2.4 Transmission characteristics" and make sure that the line loss is within the judgment value.

#### 4.1.3.2. Grounding method

For details on the grounding method, refer to "3.3.2 Grounding method".

## 4.2. 100 Mbps (Optical)

### 4.2.1. Selecting devices to be connected

#### 4.2.1.1. Optical fiber cable

For 100 Mbps (optical) CC-Link IE TSN, it is recommended to use the POF cable and PCF cable recommended by CLPA. Typical specification is shown in Table 4.2.1.1-1.

Table 4.2.1.1-1 Example of optical fiber cable specifications

No.	Item		Specifications	
1	Optical fiber type		Multimode SI type plastic optical fiber cable (SI-POF)	Multimode SI type plastic clad fiber cable (SI-PCF)
2	Core	Material	Plastic resin	Quartz glass
		External diameter	980±60 μm	200±8 μm
3	Clad	Material	Plastic resin	Plastic resin
		External diameter	1000±60 μm	230±10 μm
4	Use temperature		-20 to 70°C	-20 to 70°C
5	Allowable bending radius		80 mm (after installation)	25 mm (after installation)
			160 mm (during installation)	50 mm (during installation)
6	Transmission loss		170 (dB/km) or less (λ = 650 nm)	19 (dB/km) or less (λ = 650 nm)

#### 4.2.1.2. Optical connector

For 100 Mbps (optical) CC-Link IE TSN, it is recommended to use the optical cable recommended by CLPA. The optical connector is an F07 type connector compliant with IEC 61754-16 (JIS C 5976). Typical specification is shown in Table 4.2.1.2-1.

Table 4.2.1.2-1 Example of optical connector specifications

No.	Item		
1	Optical connector type	F07 connector	
2	Compliant standard	IEC 61754-16(JIS C 5976)	
3	Connection loss	POF	2.0 dB or lower
		PCF	0.8 dB or lower (for master fiber)
4	Polishing method	Not defined	

## 4.2.2. Checking wiring

### 4.2.2.1. Wiring length

In the CC-Link IE TSN specification, the maximum physical wiring length between nodes is 20 m for POF, and 100 m for PCF.

### 4.2.2.2. Precautions on connectors and cable connections

In accordance with the processing procedure specified by the connector manufacturer, work with due care when performing connection. For details, refer to "4.2.3 Installation and wiring".

### 4.2.2.3. Transmission characteristics

When installing the optical cable, check that the line loss between the nodes is within the recommended line loss value.

The recommended line loss values for plastic optical fiber cable (POF) and plastic clad fiber (PCF) are shown in Table 4.2.2.3-1.

Table 4.2.2.3-1 Recommended line loss value

Optical fiber type	Recommended line loss value
POF	9.5 dB
PCF	3.3 dB

## 4.2.3. Installation and wiring

### 4.2.3.1. Precautions on installing cable

#### 4.2.3.1.1. Installation

When installing optical cables, make sure to observe the following precautions.

- Installation route
  - Use pits, ducts or cable racks as much as possible in the installation route.
  - In the case of a pipeline such as a conduit, select the pipe diameter while taking the dimensions of the connector and others into consideration. Also, when providing a pull box in the middle of a pipeline, select one that satisfies the allowable bending radius of the cable.
  - Use a dedicated installation route as much as possible. When sharing with other cables, lay the optical fiber cable last.
  - The route should be free of water and oil intrusion, and high/low temperatures outside the applicable ambient temperature.
- Pipeline
  - Do not directly draw the cable; instead fix it to a cable-extending rope and lay it. Depending on the structure, some cables can be drawn directly so check with the manufacturer.
- Precautions on extending lines
  - The pulling speed of the cable shall be 10 m/min or less and perform tip drawing. Also, extend the line under 1/2 or less allowable tension so that the tension applied to the cable is even.
  - The bending radius at the time of line extension should be at least twice the allowable bending radius.
  - During installation, make sure not to twist the cable. In particular, since some hanger rollers have a structure that tends to cause twisting, it is recommended to use a metal wheel when installing long cable.
  - Be careful not to cause kinking (local bending) of the cable.

- Protection of allowable tension
  - When installing a cable vertically or in the case of aerial wiring, support so that the tension due to the weight of the cable itself does not exceed the allowable tension.
- Prevention of moisture infiltration
  - Generally, the optical fiber itself has poor water resistance and water infiltration from the end of the optical cable may have an adverse effect in the long term. Furthermore, in some cases, dew condensation caused by the temperature gradient of the optical cable installation route infiltrates inside the optical cable, which could adversely affect the cable. When installing an optical cable, make sure to provide waterproofing on the end of the optical cable.
- Protection of the connector part
  - When installing a cable, do not bend the connector part and protect it using a vinyl hose or a pulling eye. Also, the connector part is very weak to shock and tension, so do not pull it.
- Effect of plasticizer added material
  - When using POF, which is a plastic optical fiber, vinyl tape and binding bands containing migratory plasticizers could affect the optical characteristics of optical fibers. Also, as there is a possibility that chemical substances may affect the optical characteristics, check beforehand for any such influence in the environment.
- Cable side pressure/twist
  - When side pressure or twist is applied to the optical fiber, the optical cable itself deforms, stress is applied to the internal optical fiber, transmission loss increases, as a result, the cable could break. Do not tighten the optical cable strongly using a nylon band (tie wrap) or the like as the same condition occurs when bundled.
- Others
  - For waterproofing purposes, seal both ends of the cable except during work.
  - Use care while handling because the tip of the optical fiber is sharp.
  - Do not touch the tip of the optical connector or bump it.

#### 4.2.3.1.2. Fusion splicing and adapter connection

Be advised that we do not recommend use of fusing and relay adapters.

#### 4.2.3.2. Grounding method

For details on the grounding method, refer to 3.3.2 Grounding method.



## APPENDIX

### A. Supplementary Explanation Supporting Twisted Pair Cables

#### A1. Conductor structure of FA cable

Different kinds of conductors are used depending on the application.

In line with that, RJ45 connectors (plugs) include single-wire, twisted-wire, and common types.

Certain combinations cannot be used. For example, a single-wire cable cannot be combined with a connector for twisted wire.

Table A-1 Cable types

Type of conductor	Application
Single-wire	For fixed wire
Twisted wire (7-strand twisted wire)	For fixed wiring, good flexibility but short communication distance
Twisted wire (aggregated twisted wire)	For movable parts and othes (depends on the manufacturer's specifications)

For the conductor thickness, the US wire gauge standard (AWG: American wire gauge) is used. The larger the number, the smaller the diameter. In Japan, the unit called sq of the JIS standard may be used.

It is important to match the thickness and type of conductors and the overall dimensions of the cable to the compatible cable specifications of the connector.

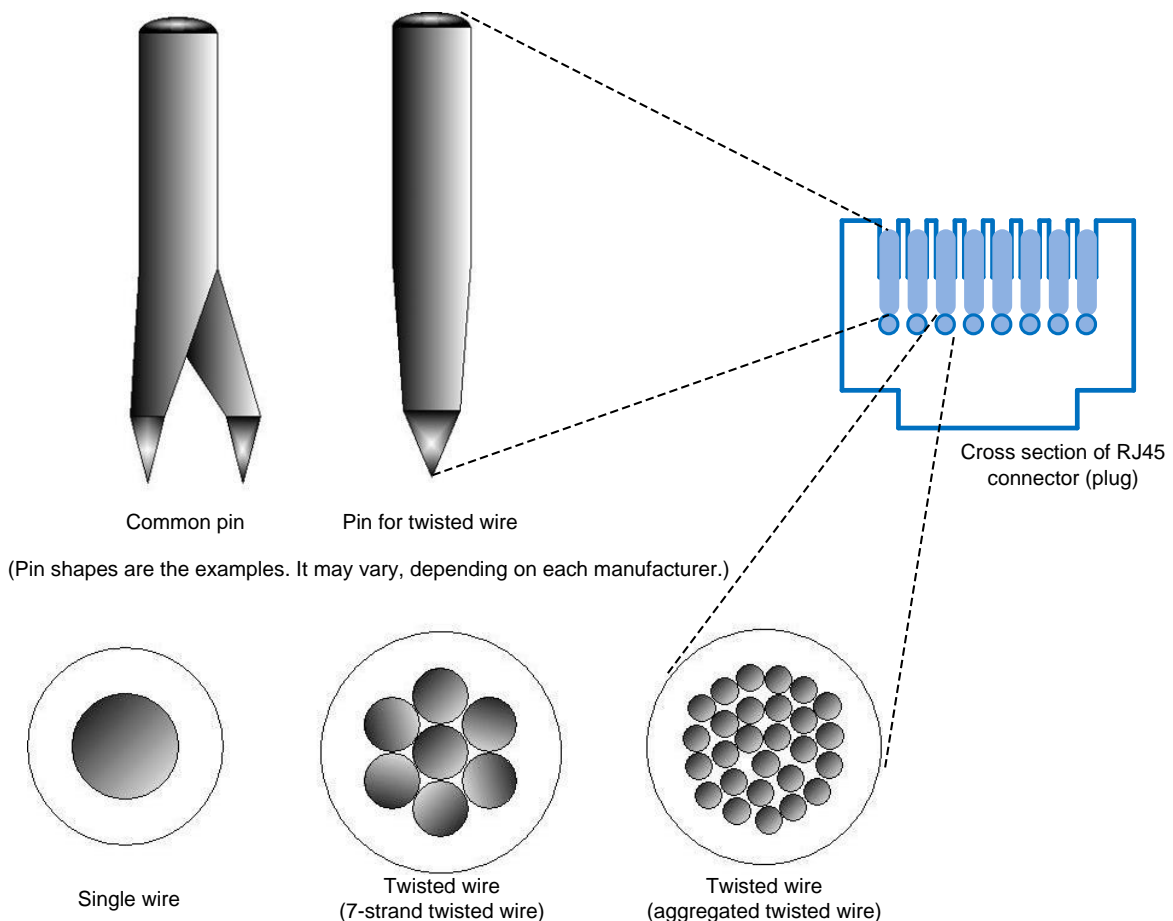

Figure A-1-1 Example pin shapes and conductor types of J45 connectors (plugs)

## A2. Pin end height (crimp height)

The height of the part where the RJ45 plug terminal fixes the wire core. Measuring the pin terminal height is one of the important management items to check connection reliability.

Pin terminal height lower limit: 5.89 mm, Upper limit: 6.15 mm

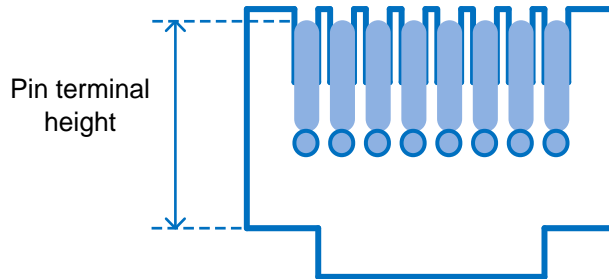

Figure A-1-2 Pin terminal height of RJ45 connector (plug)

If the pin terminal height is smaller than the specified value, it indicates that the plug is tightened excessively. In such a case, after it is inserted in the jack, contact with the pins of the jack weakens. If the pin terminal height is larger than the specified value, it indicates that the fixing of the plug terminal and the core wire is weak. In such a case, there is a possibility of a conduction failure, an increase in the contact resistance value, or the wire conductor could easily come off. Also, after inserting the connector into the jack, the jack pin may be deformed.

Always use the special tool specified by the manufacturer so as to achieve a uniform height.

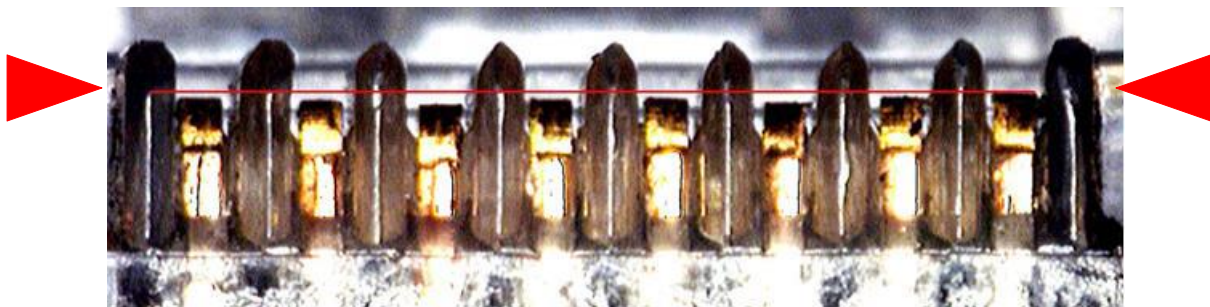

Figure A-1-3 Example of uneven pin terminal height of crimp type RJ45 connector (plug)

## A3. Deformation of connector

Before connecting units, be careful not to apply external force such as side pressure or impact the connector.

Connecting with a deformed connector could cause a malfunction or damage to the connection part on the device side due to poor connection.

To prevent external damage of the connector before connecting, it is effective to protect the connector using a tube, cushioning material or the like.



Example of deformed connector

Example of normal connector

Figure A-1-4 RJ45 Connector deformation cases